

The S-19519 Series, developed by using high-withstand voltage CMOS technology, is a low dropout positive voltage regulator with the window watchdog timer and the reset function, which has high-withstand voltage. The monitoring time of watchdog timer can be adjusted by an external capacitor. Moreover, a voltage detection circuit which monitors the output voltage is also prepared.

ABLIC Inc. offers a "thermal simulation service" which supports the thermal design in conditions when our power management ICs are in use by customers. Our thermal simulation service will contribute to reducing the risk in the thermal design at customers' development stage.

ABLIC Inc. also offers FIT rate calculated based on actual customer usage conditions in order to support customer functional safety design.

Contact our sales representatives for details.

Caution This product can be used in vehicle equipment and in-vehicle equipment. Before using the product for these purposes, it is imperative to contact our sales representatives.

■ Features

Regulator block

- Output voltage: 3.3 V, 5.0 V
- Input voltage: 3.0 V to 36.0 V
- Output voltage accuracy: $\pm 2.0\%$ ($T_j = -40^\circ\text{C}$ to $+150^\circ\text{C}$)
- Dropout voltage: 100 mV typ. (5.0 V output product, $I_{OUT} = 100$ mA)
- Output current: Possible to output 500 mA ($V_{IN} = V_{OUT(S)} + 1.0$ V)^{*1}
- Input and output capacitors: A ceramic capacitor of 1.0 μF or more can be used.
- Built-in overcurrent protection circuit: Limits overcurrent of output transistor.
- Built-in thermal shutdown circuit: Detection temperature 170°C typ.
- Built-in ON / OFF circuit: Ensures long battery life.

Detector block

- Detection voltage: 2.6 V to 4.7 V, selectable in 0.1 V step
- Detection voltage accuracy: $\pm 2.0\%$ ($T_j = -40^\circ\text{C}$ to $+150^\circ\text{C}$)
- Hysteresis width: 0.12 V min.
- Release delay time is adjustable^{*2}: 20 ms typ. ($C_{DLY} = 10$ nF) (S-19519A/B Series)
0.56 ms typ. ($C_{DLY} = 3.3$ nF) (S-19519C Series)

Watchdog timer block

- Watchdog activation current: 1.5 mA typ. (WADJ pin is open)
- Watchdog trigger time is adjustable^{*2}: 46 ms typ. ($C_{DLY} = 10$ nF) (S-19519A/B Series)
15.2 ms typ. ($C_{DLY} = 3.3$ nF) (S-19519C Series)
- Product type is selectable: S-19519A/C Series
(TO-252-9S package product, HSOP-8A package product)
S-19519B Series (HTSSOP-16 package product)
- Autonomous watchdog operation function: Watchdog timer operates due to detection of load current.
- Watchdog mode: Window mode

Overall

- Current consumption: 3.2 μA typ. (During regulator operation, during watchdog timer deactivation)
0.1 μA typ. (During regulator stop)
- Operation temperature range: $T_a = -40^\circ\text{C}$ to $+125^\circ\text{C}$
- Lead-free (Sn 100%), halogen-free
- Withstand 45 V load dump
- AEC-Q100 qualified^{*3}

*1. Please make sure that the loss of the IC will not exceed the power dissipation when the output current is large.

*2. The release delay time and the watchdog trigger time can be adjusted by connecting C_{DLY} to the DLY pin.

*3. Contact our sales representatives for details.

■ Applications

- Constant-voltage power supply for automotive electric component, monitoring of microcontroller

■ Packages

- TO-252-9S
- HSOP-8A
- HTSSOP-16

■ **Block Diagrams**

1. **S-19519A/C Series (TO-252-9S package product, HSOP-8A package product)**

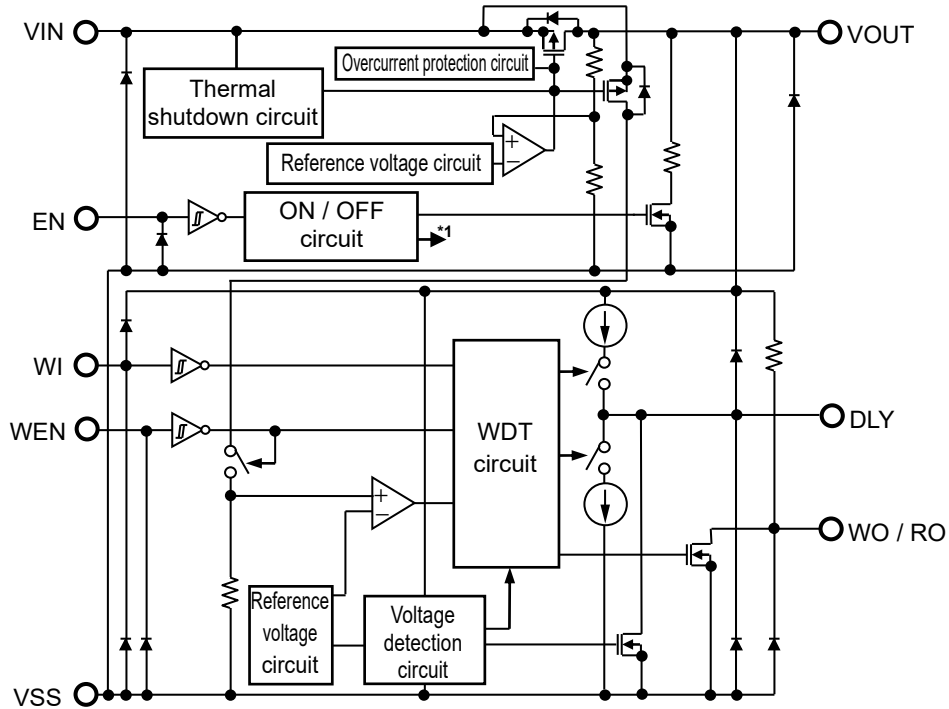

*1. The ON / OFF circuit controls the internal circuit and the output transistor.

Figure 1

2. **S-19519B Series (HTSSOP-16 package product)**

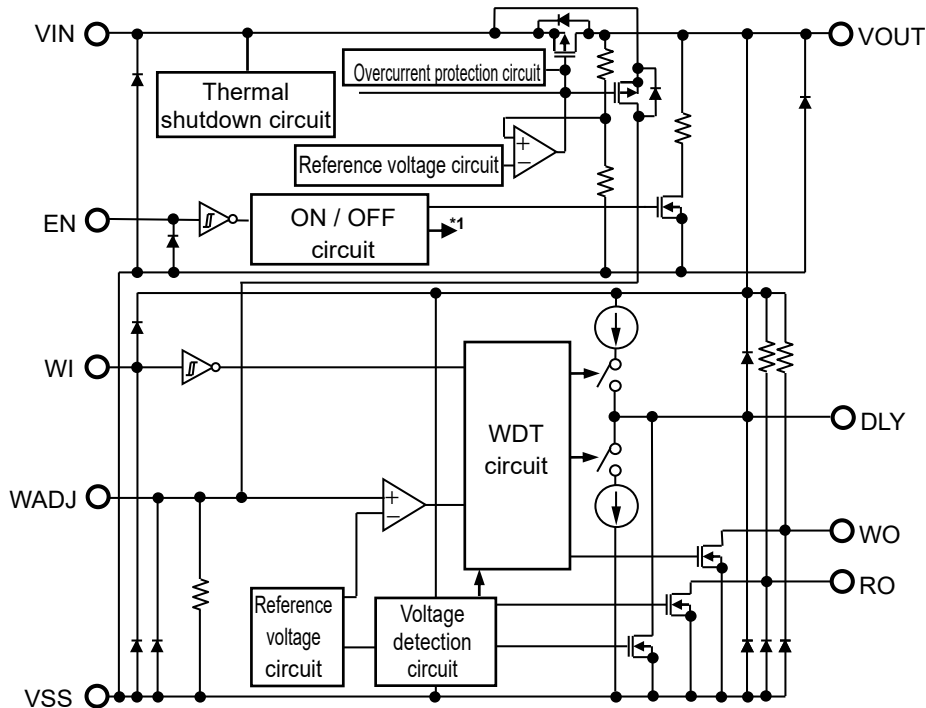

*1. The ON / OFF circuit controls the internal circuit and the output transistor.

Figure 2

■ **AEC-Q100 Qualified**

This IC supports AEC-Q100 for the operation temperature grade 1.
 Contact our sales representatives for details of AEC-Q100 reliability specification.

■ **Product Name Structure**

1. **Product name**

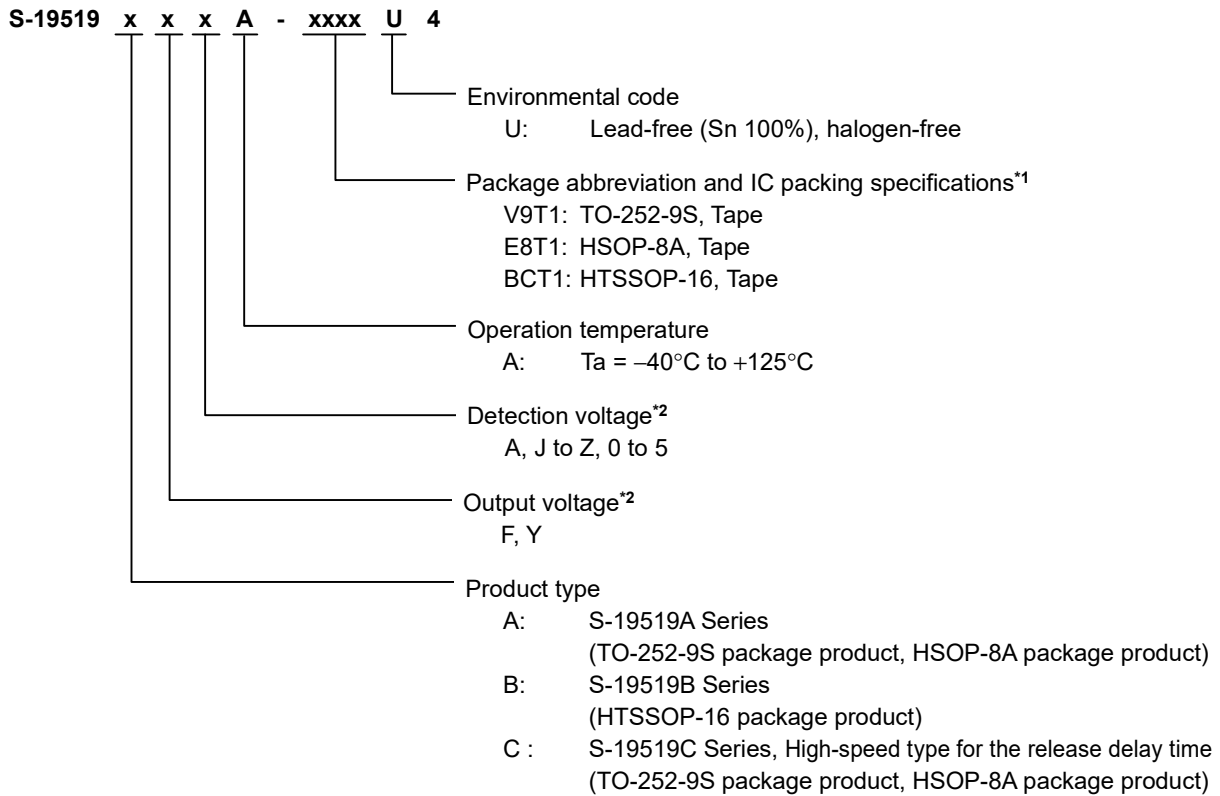

*1. Refer to the tape drawing.
 *2. Refer to "2. Product option list".

2. **Product option list**

Table 1 Output Voltage

Set Output Voltage	Symbol
5.0 V	F
3.3 V	Y

Table 2 Detection Voltage

Set Detection Voltage	Symbol
4.7 V	J
4.6 V	K
4.5 V	L
4.43 V	A
4.4 V	M
4.3 V	N
4.2 V	P
4.1 V	Q
4.0 V	R
3.9 V	S
3.8 V	T
3.7 V	U

Set Detection Voltage	Symbol
3.6 V	V
3.5 V	W
3.4 V	X
3.3 V	Y
3.2 V	Z
3.1 V	0
3.0 V	1
2.9 V	2
2.8 V	3
2.7 V	4
2.6 V	5

Remark Set output voltage ≥ Set detection voltage + 0.3 V

3. Packages

Table 3 Package Drawing Codes

Package Name	Dimension	Tape	Reel	Land
TO-252-9S	VA009-A-P-SD	VA009-A-C-SD	VA009-A-R-SD	VA009-A-L-SD
HSOP-8A	FH008-A-P-SD	FH008-A-C-SD	FH008-A-R-SD	FH008-A-L-SD
HTSSOP-16	FR016-A-P-SD	FR016-A-C-SD	FR016-A-R-SD	FR016-A-L-SD

4. Product name list

4.1 S-19519A Series (TO-252-9S package product, HSOP-8A package product)

Table 4

Output Voltage (V _{OUT})	Detection Voltage (-V _{DET})	Release Delay Time (t _{DLY}) ^{*1}	TO-252-9S	HSOP-8A
3.3 V ± 2.0%	2.8 V ± 2.0%	20.0 ms	S-19519AY3A-V9T1U4	S-19519AY3A-E8T1U4
3.3 V ± 2.0%	2.9 V ± 2.0%	20.0 ms	S-19519AY2A-V9T1U4	S-19519AY2A-E8T1U4
3.3 V ± 2.0%	3.0 V ± 2.0%	20.0 ms	S-19519AY1A-V9T1U4	S-19519AY1A-E8T1U4
5.0 V ± 2.0%	4.2 V ± 2.0%	20.0 ms	S-19519AFPA-V9T1U4	S-19519AFPA-E8T1U4
5.0 V ± 2.0%	4.6 V ± 2.0%	20.0 ms	S-19519AFKA-V9T1U4	S-19519AFKA-E8T1U4
5.0 V ± 2.0%	4.7 V ± 2.0%	20.0 ms	S-19519AFJA-V9T1U4	S-19519AFJA-E8T1U4

*1. C_{DLY} = 10 nF

Remark Please contact our sales representatives for products other than the above.

4.2 S-19519B Series (HTSSOP-16 package product)

Table 5

Output Voltage (V _{OUT})	Detection Voltage (-V _{DET})	Release Delay Time (t _{DLY}) ^{*1}	HTSSOP-16
3.3 V ± 2.0%	2.8 V ± 2.0%	20.0 ms	S-19519BY3A-BCT1U4
3.3 V ± 2.0%	2.9 V ± 2.0%	20.0 ms	S-19519BY2A-BCT1U4
3.3 V ± 2.0%	3.0 V ± 2.0%	20.0 ms	S-19519BY1A-BCT1U4
5.0 V ± 2.0%	4.2 V ± 2.0%	20.0 ms	S-19519BFPA-BCT1U4
5.0 V ± 2.0%	4.6 V ± 2.0%	20.0 ms	S-19519BFKA-BCT1U4
5.0 V ± 2.0%	4.7 V ± 2.0%	20.0 ms	S-19519BFJA-BCT1U4

*1. C_{DLY} = 10 nF

Remark Please contact our sales representatives for products other than the above.

4.3 S-19519C Series (TO-252-9S package product, HSOP-8A package product)

Table 6

Output Voltage (V _{OUT})	Detection Voltage (-V _{DET})	Release Delay Time (t _{DLY}) ^{*1}	TO-252-9S	HSOP-8A
3.3 V ± 2.0%	2.8 V ± 2.0%	0.56 ms	S-19519CY3A-V9T1U4	S-19519CY3A-E8T1U4
5.0 V ± 2.0%	4.43 V ± 2.0%	0.56 ms	S-19519CFAA-V9T1U4	S-19519CFAA-E8T1U4

*1. C_{DLY} = 3.3 nF

Remark Please contact our sales representatives for products other than the above.

Pin Configurations

1. TO-252-9S

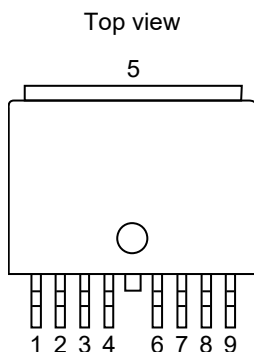

Figure 3

Table 7 S-19519A/C Series

Pin No.	Symbol	Description	
1	VOUT	Voltage output pin (Regulator block)	
2	WEN	Watchdog enable pin	
3	DLY	Connection pin for release delay time and monitoring time adjustment capacitor	
4	NC*1	No connection	
5	VSS	GND pin	
6	WO / RO*2	WO	Watchdog output pin
		RO	Reset output pin
7	WI	Watchdog input pin	
8	EN	Enable pin	
9	VIN	Voltage input pin (Regulator block)	

- *1. The NC pin is electrically open.
The NC pin can be connected to the VIN pin or the VSS pin.
- *2. The WO / RO pin combines the watchdog output pin and the reset output pin.

2. HSOP-8A

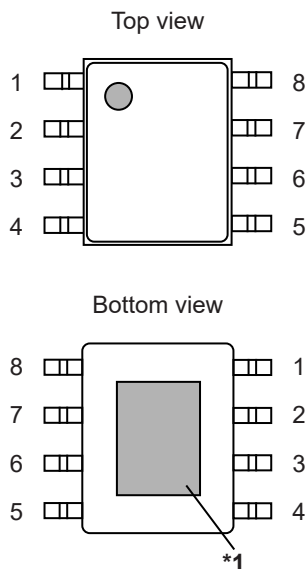

Figure 4

Table 8 S-19519A/C Series

Pin No.	Symbol	Description	
1	VOUT	Voltage output pin (Regulator block)	
2	WEN	Watchdog enable pin	
3	VSS	GND pin	
4	DLY	Connection pin for release delay time and monitoring time adjustment capacitor	
5	WO / RO*2	WO	Watchdog output pin
		RO	Reset output pin
6	WI	Watchdog input pin	
7	EN	Enable pin	
8	VIN	Voltage input pin (Regulator block)	

- *1. Connect the heat sink of backside at shadowed area to the board, and set electric potential GND.
However, do not use it as the function of electrode.
- *2. The WO / RO pin combines the watchdog output pin and the reset output pin.

3. HTSSOP-16

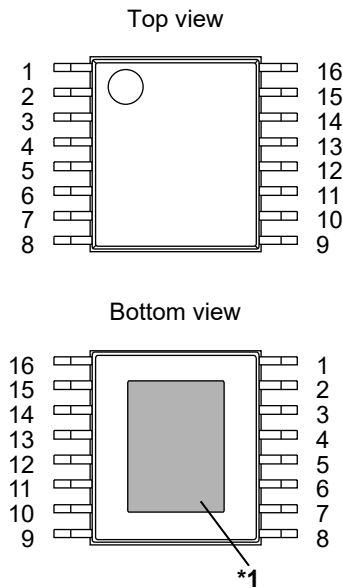

Figure 5

Table 9 S-19519B Series

Pin No.	Symbol	Description
1	VOUT	Voltage output pin (Regulator block)
2	VOUT	Voltage output pin (Regulator block)
3	NC*2	No connection
4	WADJ	Connection pin for watchdog activation threshold current adjustment resistor
5	NC*2	No connection
6	VSS	GND pin
7	NC*2	No connection
8	DLY	Connection pin for release delay time and monitoring time adjustment capacitor
9	RO	Reset output pin
10	WO	Watchdog output pin
11	NC*2	No connection
12	WI	Watchdog input pin
13	NC*2	No connection
14	EN	Enable pin
15	VIN	Voltage input pin (Regulator block)
16	VIN	Voltage input pin (Regulator block)

- *1. Connect the heat sink of backside at shadowed area to the board, and set electric potential GND. However, do not use it as the function of electrode.
- *2. The NC pin is electrically open.
The NC pin can be connected to the VIN pin or the VSS pin.

■ Absolute Maximum Ratings

Table 10

(T_j = -40°C to +150°C unless otherwise specified)

Item	Symbol	Absolute Maximum Rating	Unit
VIN pin voltage	V _{IN}	V _{SS} - 0.3 to V _{SS} + 45.0	V
EN pin voltage	V _{EN}	V _{SS} - 0.3 to V _{SS} + 45.0	V
VOOUT pin voltage	V _{OUT}	V _{SS} - 0.3 to V _{IN} + 0.3 ≤ V _{SS} + 7.0	V
DLY pin voltage	V _{DLY}	V _{SS} - 0.3 to V _{OUT} + 0.3 ≤ V _{SS} + 7.0	V
RO pin voltage	V _{RO}	V _{SS} - 0.3 to V _{OUT} + 0.3 ≤ V _{SS} + 7.0	V
WADJ pin voltage	V _{WADJ}	V _{SS} - 0.3 to V _{IN} + 0.3 ≤ V _{SS} + 7.0	V
WEN pin voltage	V _{WEN}	V _{SS} - 0.3 to V _{SS} + 7.0	V
WI pin voltage	V _{WI}	V _{SS} - 0.3 to V _{OUT} + 0.3 ≤ V _{SS} + 7.0	V
WO pin voltage	V _{WO}	V _{SS} - 0.3 to V _{OUT} + 0.3 ≤ V _{SS} + 7.0	V
WO / RO pin voltage	V _{WO / RO}	V _{SS} - 0.3 to V _{OUT} + 0.3 ≤ V _{SS} + 7.0	V
Output current	I _{OUT}	650	mA
	I _{RO}	30	mA
	I _{WO}	30	mA
	I _{WO / RO}	30	mA
Junction temperature	T _j	-40 to +150	°C
Operation ambient temperature	T _{opr}	-40 to +125	°C
Storage temperature	T _{stg}	-40 to +150	°C

Caution The absolute maximum ratings are rated values exceeding which the product could suffer physical damage. These values must therefore not be exceeded under any conditions.

■ Thermal Resistance Value

Table 11

Item	Symbol	Condition	Min.	Typ.	Max.	Unit	
Junction-to-ambient thermal resistance*1, *2	θ _{JA}	TO-252-9S	Board A	-	84	-	°C/W
			Board B	-	-	-	°C/W
			Board C	-	-	-	°C/W
			Board D	-	-	-	°C/W
			Board E	-	24	-	°C/W
		HSOP-8A	Board A	-	105	-	°C/W
			Board B	-	-	-	°C/W
			Board C	-	-	-	°C/W
			Board D	-	-	-	°C/W
			Board E	-	31	-	°C/W
		HTSSOP-16	Board A	-	91	-	°C/W
			Board B	-	65	-	°C/W
			Board C	-	34	-	°C/W
			Board D	-	32	-	°C/W
			Board E	-	26	-	°C/W

*1. Test environment: compliance with JEDEC STANDARD JESD51-2A

*2. Measurement values when this IC is mounted on each board

Remark Refer to "■ Power Dissipation" and "Test Board" for details.

■ Recommended Operation Conditions

Table 12

Item	Symbol	Condition	Min.	Typ.	Max.	Unit
VIN pin voltage	VIN	–	3.0	–	36.0	V
		Autonomous watchdog operation function*1	VOUT(S) + 1.0	–	36.0	V
EN pin voltage	VEN	–	0	–	VIN	V
WEN pin voltage	VWEN	S-19519A/C Series	0	–	VOUT	V
WI pin voltage	VWI	–	0	–	VOUT	V
Watchdog input "H" time*2	t _{high}	–	5.0	–	–	μs
Watchdog input "L" time*2	t _{low}	–	5.0	–	–	μs
Watchdog input frequency*2	f _{WI}	Duty ratio 50%	–	–	0.2	MHz
Input capacitance	C _{IN}	–	1.0	–	–	μF
Output capacitance	C _L	–	1.0	–	–	μF
Equivalent series resistance	R _{ESR}	Output capacitor (C _L)	–	–	100	Ω
Release delay time and monitoring time adjustment capacitance*3	C _{DLY}	S-19519A/B Series	1	10	–	nF
		S-19519C Series	3.3	–	–	nF
Watchdog activation threshold current adjustment resistance*4	R _{WADJ,ext}	S-19519B Series, Connected to WADJ pin	10	–	–	kΩ
External pull-up resistance for output pin	R _{extW}	S-19519B Series Connected to WO pin	3	–	–	kΩ
	R _{extR}	S-19519A/C Series Connected to WO / RO pin	3	–	–	kΩ
		S-19519B Series Connected to RO pin	3	–	–	kΩ

- *1. Refer to "3. Watchdog timer block" in "■ Operation" for the autonomous watchdog operation function.
- *2. When inputting a rising edge that satisfies the condition of Figure 6 to the WI pin, the watchdog timer detects a trigger.
The signal input from the monitored object by the watchdog timer should satisfy the condition of Figure 6.
- *3. Refer to "2. Release delay time and monitoring time adjustment capacitor (C_{DLY})" in "■ Selection of External Parts" for the details.
- *4. Refer to "3. Watchdog activation threshold current adjustment resistor (R_{WADJ,ext})" in "■ Selection of External Parts" for the details.

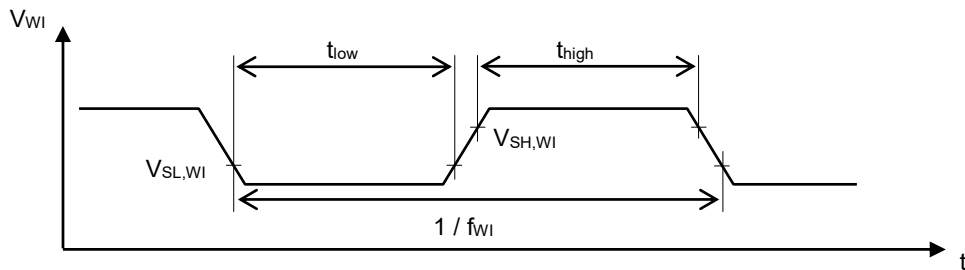

Figure 6

Caution Generally a series regulator may cause oscillation, depending on the selection of external parts. Confirm that no oscillation occurs in the actual application using capacitors that meet the above C_{IN}, C_L, and R_{ESR}.

■ Electrical Characteristics

1. Regulator block

Table 13

($V_{IN} = 13.5 \text{ V}$, $T_j = -40^\circ\text{C}$ to $+150^\circ\text{C}$ unless otherwise specified)

Item	Symbol	Condition	Min.	Typ.	Max.	Unit	Test Circuit	
Output voltage*1	$V_{OUT(E)}$	$V_{OUT(S)} + 1.0 \text{ V} \leq V_{IN} \leq 18.0 \text{ V}$, $1 \text{ mA} \leq I_{OUT} \leq 100 \text{ mA}$	$V_{OUT(S)} - 2.0\%$	$V_{OUT(S)}$	$V_{OUT(S)} + 2.0\%$	V	1	
Output current*2	I_{OUT}	$V_{IN} \geq V_{OUT(S)} + 1.0 \text{ V}$	500*7	–	–	mA	2	
Dropout voltage*3	V_{drop}	$I_{OUT} = 100 \text{ mA}$	$V_{OUT(S)} = 3.3 \text{ V}$	–	120	240	mV	1
			$V_{OUT(S)} = 5.0 \text{ V}$	–	100	200	mV	1
		$I_{OUT} = 500 \text{ mA}$	$V_{OUT(S)} = 3.3 \text{ V}$	–	650	1200	mV	1
			$V_{OUT(S)} = 5.0 \text{ V}$	–	510	1000	mV	1
Line regulation*4	$\frac{\Delta V_{OUT1}}{\Delta V_{IN} \cdot V_{OUT}}$	$V_{OUT(S)} + 1.0 \text{ V} \leq V_{IN} \leq 36.0 \text{ V}$, $I_{OUT} = 1 \text{ mA}$	–	0.01	0.02	%/V	1	
Load regulation*5	ΔV_{OUT2}	$V_{IN} = V_{OUT(S)} + 1.0 \text{ V}$, $1 \text{ mA} \leq I_{OUT} \leq 250 \text{ mA}$, $T_a = +25^\circ\text{C}$	–	10	50	mV	1	
Input voltage	V_{IN}	–	3.0	–	36.0	V	–	
EN pin input voltage "H"	$V_{SH,EN}$	–	2	–	–	V	4	
EN pin input voltage "L"	$V_{SL,EN}$	–	–	–	0.8	V	4	
EN pin input current "H"	$I_{SH,EN}$	$V_{EN} = V_{IN}$	–	–	1	μA	4	
EN pin input current "L"	$I_{SL,EN}$	$V_{EN} = 0 \text{ V}$	–	–	0.1	μA	4	
Ripple rejection	RR	$V_{IN} = 13.5 \text{ V}$, $I_{OUT} = 30 \text{ mA}$, $f = 100 \text{ Hz}$, $\Delta V_{rip} = 1.0 \text{ V}_{p-p}$	$V_{OUT(S)} = 3.3 \text{ V}$	–	65	–	dB	3
			$V_{OUT(S)} = 5.0 \text{ V}$	–	60	–	dB	3
Limit current*6	I_{LIM}	$V_{IN} = V_{OUT(S)} + 1.0 \text{ V}$, $T_a = +25^\circ\text{C}$	490	700	960	mA	2	
Short-circuit current	I_{short}	$V_{IN} = 13.5 \text{ V}$, $V_{OUT} = 0 \text{ V}$, $T_a = +25^\circ\text{C}$	75	160	245	mA	2	
Thermal shutdown detection temperature	T_{SD}	Junction temperature	–	170	–	$^\circ\text{C}$	–	
Thermal shutdown release temperature	T_{SR}	Junction temperature	–	135	–	$^\circ\text{C}$	–	

*1. The accuracy is guaranteed when the input voltage, output current, and temperature satisfy the conditions listed above.

$V_{OUT(S)}$: Set output voltage

$V_{OUT(E)}$: Actual output voltage

*2. The output current when increasing the output current gradually until the output voltage has reached the value of 95% of $V_{OUT(E)}$.

*3. The difference between input voltage (V_{IN1}) and the output voltage when decreasing input voltage (V_{IN}) gradually until the output voltage has dropped out to the value of 98% of output voltage (V_{OUT3}).

$$V_{drop}: V_{IN1} - (V_{OUT3} \times 0.98)$$

V_{OUT3} : Output voltage when $V_{IN} = V_{OUT(S)} + 1.0 \text{ V}$

*4. The dependency of the output voltage against the input voltage. The value shows how much the output voltage changes due to a change in the input voltage while keeping output current constant.

*5. The dependency of the output voltage against the output current. The value shows how much the output voltage changes due to a change in the output current while keeping input voltage constant.

*6. The current limited by overcurrent protection circuit.

*7. Due to limitation of the power dissipation, this value may not be satisfied. Attention should be paid to the power dissipation when the output current is large.

This specification is guaranteed by design.

2. Detector block

Table 14

(T_J = -40°C to +150°C unless otherwise specified)

Item	Symbol	Condition	Min.	Typ.	Max.	Unit	Test Circuit
Detection voltage*1	-V _{DET}	-	-V _{DET(S)} - 2.0%	-V _{DET(S)}	-V _{DET(S)} + 2.0%	V	5
Hysteresis width*2	V _{HYS}	-	120	150	180	mV	5
Reset output voltage "H"	V _{ROH}	-	V _{OUT(S)} × 0.9	-	-	V	5
Reset output voltage "L"	V _{ROL}	V _{OUT} ≥ 1.0 V, R _{extR} ≥ 3 kΩ, Connected to V _{OUT} pin	-	0.2	0.4	V	5
Reset pull-up resistance	R _{RO}	V _{OUT} pin internal resistance, V _{OUT} ≥ +V _{DET}	20	30	45	kΩ	-
Reset output current	I _{RO}	V _{RO} = 0.4 V, V _{OUT} = -V _{DET(S)} × 0.95	3.0	-	-	mA	6
Release delay time*3	t _{rd}	S-19519A/B Series, C _{DLY} = 10 nF	16	20	24	ms	5
		S-19519C Series, C _{DLY} = 3.3 nF	0.45	0.56	0.70	ms	5
Reset reaction time*4	t _{rr}	-	-	-	200	μs	5

*1. The V_{OUT} pin voltage at which the output of the RO pin switches from "H" to "L".

-V_{DET(S)}: Set detection voltage
 -V_{DET}: Actual detection voltage

*2. The voltage difference between the detection voltage (-V_{DET}) and the release voltage (+V_{DET}). The relation between the actual output voltage (V_{OUT(E)}) of the regulator block and the actual release voltage (+V_{DET} = -V_{DET} + V_{HYS}) of the detector block is as follows.

$$V_{OUT(E)} > +V_{DET}$$

*3. The time from when V_{OUT} exceeds +V_{DET} to when the RO pin output inverts (Refer to **Figure 7**). This value changes according to the release delay time and monitoring time adjustment capacitor (C_{DLY}).

*4. The time from when V_{OUT} falls below -V_{DET} to when the RO pin output inverts (Refer to **Figure 8**).

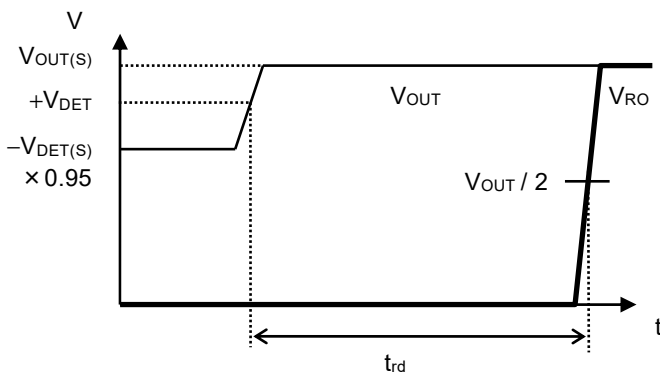

Figure 7 Release Delay Time

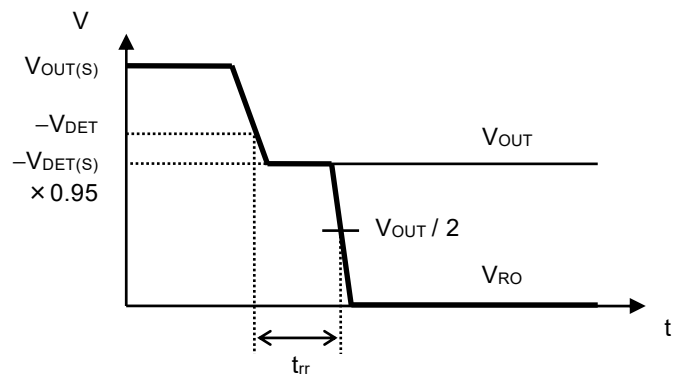

Figure 8 Reset Reaction Time

3. Watchdog timer block

3.1 S-19519A/C Series (TO-252-9S package product, HSOP-8A package product)

Table 15

($V_{IN} = 13.5\text{ V}$, $T_J = -40^\circ\text{C}$ to $+150^\circ\text{C}$ unless otherwise specified)

Item	Symbol	Condition	Min.	Typ.	Max.	Unit	Test Circuit
Watchdog activation threshold current	$I_{O,WDact}$	–	1.1	1.5	1.9	mA	9
Watchdog deactivation threshold current	$I_{O,WDdeact}$	–	0.85	1.25	–	mA	9
WI pin input voltage "H"	$V_{SH,WI}$	–	$V_{OUT(S)} \times 0.7$	–	–	V	7
WI pin input voltage "L"	$V_{SL,WI}$	–	–	–	$V_{OUT(S)} \times 0.3$	V	7
WI pin input current "H"	$I_{SH,WI}$	$V_{WI} = V_{OUT(S)}$	–	–	1	μA	7
WI pin input current "L"	$I_{SL,WI}$	$V_{WI} = 0\text{ V}$	–	–	0.1	μA	7
WEN pin input voltage "H"	$V_{SH,WEN}$	–	2	–	–	V	8
WEN pin input voltage "L"	$V_{SL,WEN}$	–	–	–	0.8	V	8
WEN pin input current "H"	$I_{SH,WEN}$	$V_{WEN} = V_{OUT(S)}$	–	–	1	μA	8
WEN pin input current "L"	$I_{SL,WEN}$	$V_{WEN} = 0\text{ V}$	–	–	0.1	μA	8
Watchdog output "L" time*1	$t_{WD,L}$	S-19519A Series, $C_{DLY} = 10\text{ nF}$	9.2	11.5	13.8	ms	9
		S-19519C Series, $C_{DLY} = 3.3\text{ nF}$	3.04	3.79	4.56	ms	9
Watchdog trigger time*2	$t_{WI,tr}$	S-19519A Series, $C_{DLY} = 10\text{ nF}$	39.1	46	52.9	ms	9
		S-19519C Series, $C_{DLY} = 3.3\text{ nF}$	12.2	15.2	18.2	ms	9
Watchdog double-pulse detection time*3	$t_{WI,dp}$	S-19519A Series, $C_{DLY} = 10\text{ nF}$	9.2	11.5	13.8	ms	9
		S-19519C Series, $C_{DLY} = 3.3\text{ nF}$	3.04	3.79	4.56	ms	9

*1. The time when the WO / RO pin continues "L" after the watchdog timer detects a time-out or double-pulse (Refer to **Figure 9**). This value changes according to C_{DLY} .

*2. The time from when the watchdog timer initiates the detection of a trigger signal to when a time-out is detected and the WO / RO pin output changes to "L" (Refer to **Figure 9**). This value changes according to C_{DLY} .

*3. The time from when the watchdog timer initiates the detection of a trigger signal to when a trigger is detected again before $t_{WI,dp}$ elapses and the WO / RO pin output changes to "L" (Refer to **Figure 10**). This value changes according to C_{DLY} .

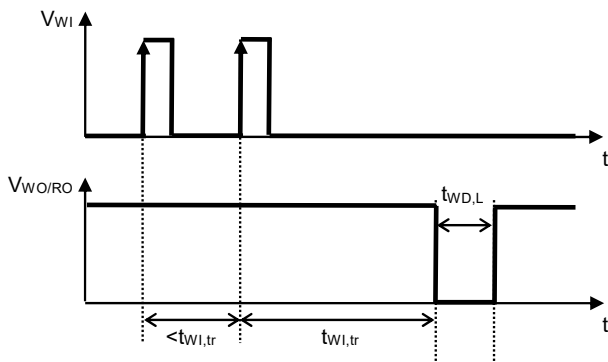

Figure 9 Watchdog Trigger Time

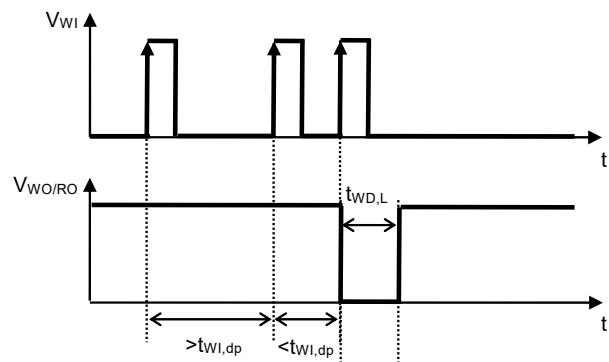

Figure 10 Watchdog Double-pulse Detection Time

3.2 S-19519B Series (HTSSOP-16 package product)

Table 16

($V_{IN} = 13.5\text{ V}$, $T_j = -40^\circ\text{C}$ to $+150^\circ\text{C}$ unless otherwise specified)

Item	Symbol	Condition	Min.	Typ.	Max.	Unit	Test Circuit
Watchdog activation threshold current	$I_{O,WDact}$	WADJ pin is open	1.1	1.5	1.9	mA	7
Watchdog deactivation threshold current	$I_{O,WDdeact}$	WADJ pin is open	0.85	1.25	–	mA	7
Watchdog activation hysteresis current	$I_{O,WDhys}$	WADJ pin is open	0.1	0.25	0.4	mA	7
Watchdog activation threshold voltage	$V_{WADJ,th}$	–	1.2	1.25	1.33	V	8
WADJ pin current ratio	$\frac{I_{OUT}}{I_{WADJ}}$	$V_{WADJ} = 0\text{ V}$, $I_{OUT} = 10\text{ mA}$	–	1700	–	–	8
WADJ pin internal resistance	$R_{WADJ,int}$	–	1000	1400	1800	k Ω	–
WI pin input voltage "H"	$V_{SH,WI}$	–	$V_{OUT(S)} \times 0.7$	–	–	V	11
WI pin input voltage "L"	$V_{SL,WI}$	–	–	–	$V_{OUT(S)} \times 0.3$	V	11
WI pin input current "H"	$I_{SH,WI}$	$V_{WI} = V_{OUT(S)}$	–	–	1	μA	11
WI pin input current "L"	$I_{SL,WI}$	$V_{WI} = 0\text{ V}$	–	–	0.1	μA	11
Watchdog output voltage "H"	V_{WOH}	–	$V_{OUT(S)} \times 0.9$	–	–	V	7
Watchdog output voltage "L"	V_{WOL}	$R_{extW} \geq 3\text{ k}\Omega$, Connected to VOUT pin	–	0.2	0.4	V	7
Watchdog pull-up resistance	R_{WO}	VOUT pin internal resistance, $V_{OUT} \geq +V_{DET}$	20	30	45	k Ω	–
Watchdog output current	I_{WO}	$V_{WO} = 0.4\text{ V}$, $V_{OUT} = -V_{DET(S)} \times 0.95$	3.0	–	–	mA	12
Watchdog output "L" time*1	$t_{WD,L}$	$C_{DLY} = 10\text{ nF}$	9.2	11.5	13.8	ms	9
Watchdog trigger time*2	$t_{WI,tr}$	$C_{DLY} = 10\text{ nF}$	39.1	46	52.9	ms	9
Watchdog double-pulse detection time*3	$t_{WI,dp}$	$C_{DLY} = 10\text{ nF}$	9.2	11.5	13.8	ms	9

*1. The time when the WO pin continues "L" after the watchdog timer detects a time-out or double-pulse (Refer to **Figure 11**). This value changes according to C_{DLY} .

*2. The time from when the watchdog timer initiates the detection of a trigger signal to when a time-out is detected and the WO pin output changes to "L" (Refer to **Figure 11**). This value changes according to C_{DLY} .

*3. The time from when the watchdog timer initiates the detection of a trigger signal to when a trigger is detected again before $t_{WI,dp}$ elapses and the WO pin output changes to "L" (Refer to **Figure 12**. This value changes according to C_{DLY} .

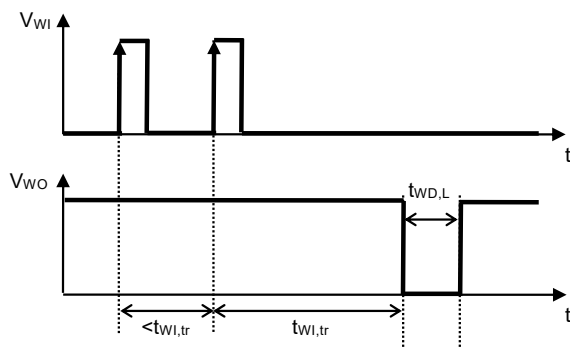

Figure 11 Watchdog Trigger Time

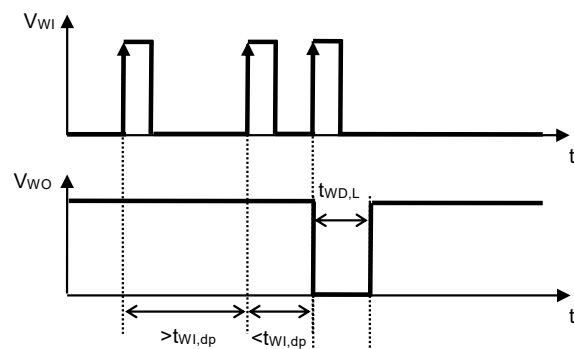

Figure 12 Watchdog Double-pulse Detection Time

4. Overall

Table 17

($V_{IN} = 13.5\text{ V}$, $T_J = -40^\circ\text{C}$ to $+150^\circ\text{C}$ unless otherwise specified)

Item	Symbol	Condition	Min.	Typ.	Max.	Unit	Test Circuit
Current consumption during operation	I _{SS1}	$V_{EN} = V_{IN}$, $I_{OUT} \leq 10\ \mu\text{A}$, during watchdog timer deactivation	–	3.2	9.8	μA	9
		S-19519A/C Series, $V_{EN} = V_{IN}$, $I_{OUT} \leq 2.5\ \text{mA}$, during watchdog timer activation, WO / RO pin = "H"	–	8.4	18	μA	9
		S-19519B Series, $V_{EN} = V_{IN}$, $I_{OUT} \leq 2.5\ \text{mA}$, during watchdog timer activation, WADJ pin is connected to VOUT pin, WO pin = "H"	–	8.4	18	μA	9
Current consumption during power-off	I _{SS2}	$V_{EN} = 0\ \text{V}$, $I_{OUT} = 0\ \text{mA}$	–	0.1	4.0	μA	10

■ **Test Circuits**

1. **S-19519A/C Series (TO-252-9S package product, HSOP-8A package product)**

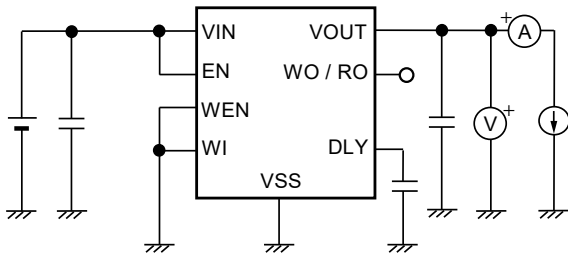

Figure 13 Test Circuit 1

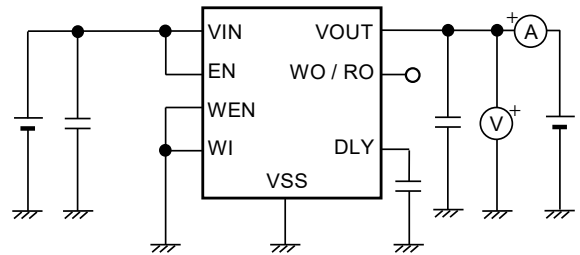

Figure 14 Test Circuit 2

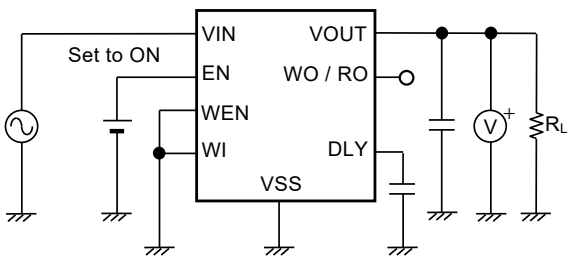

Figure 15 Test Circuit 3

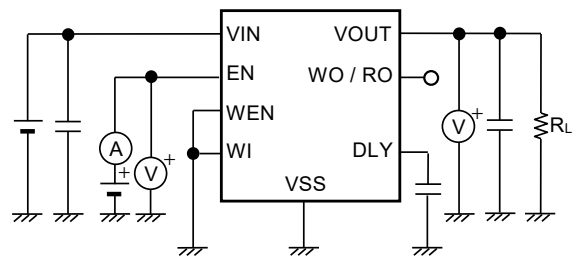

Figure 16 Test Circuit 4

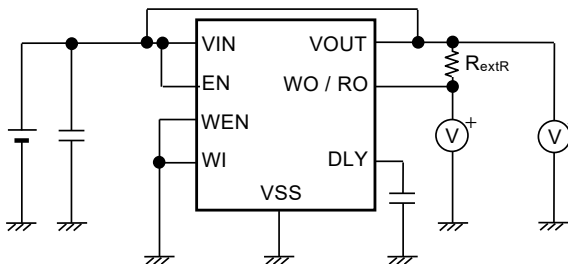

Figure 17 Test Circuit 5

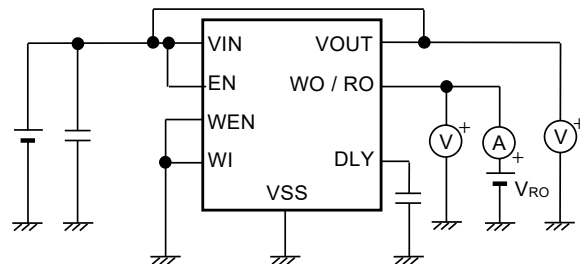

Figure 18 Test Circuit 6

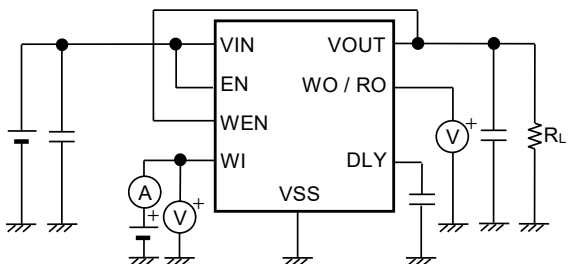

Figure 19 Test Circuit 7

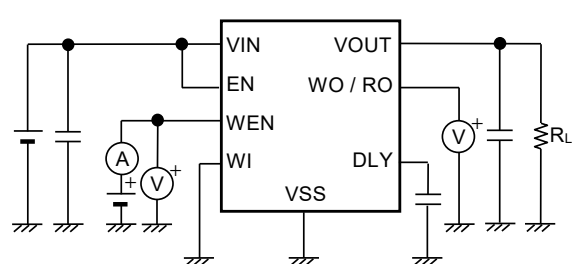

Figure 20 Test Circuit 8

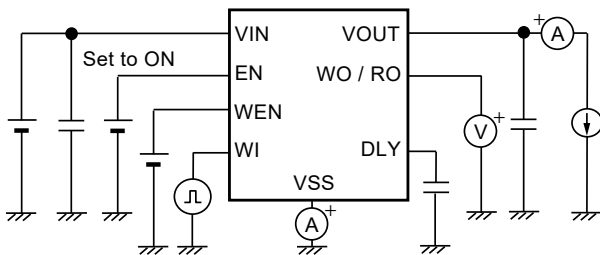

Figure 21 Test Circuit 9

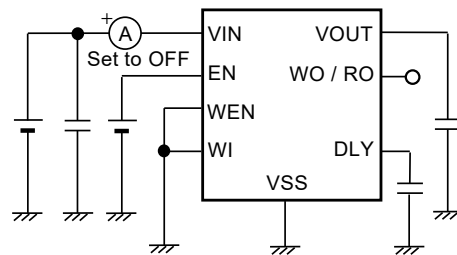

Figure 22 Test Circuit 10

2. S-19519B Series (HTSSOP-16 package product)

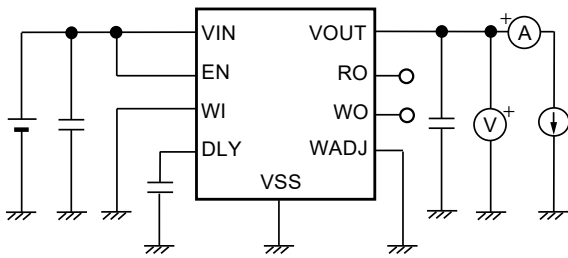

Figure 23 Test Circuit 1

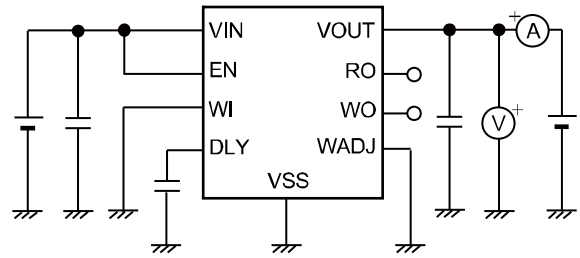

Figure 24 Test Circuit 2

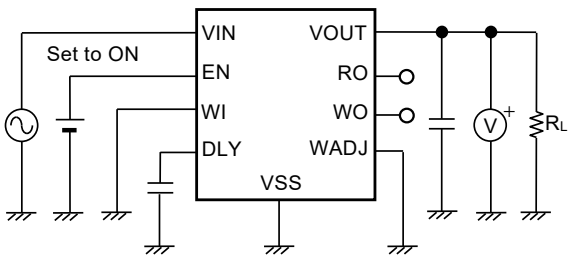

Figure 25 Test Circuit 3

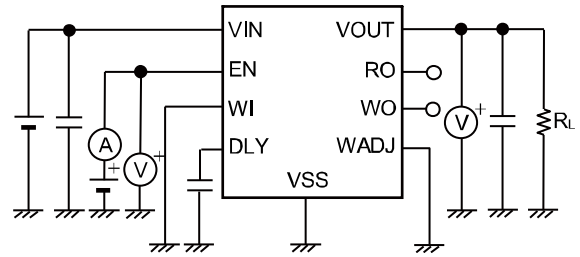

Figure 26 Test Circuit 4

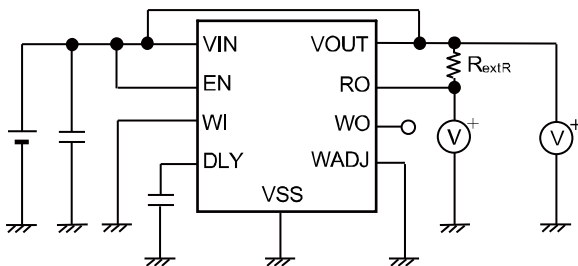

Figure 27 Test Circuit 5

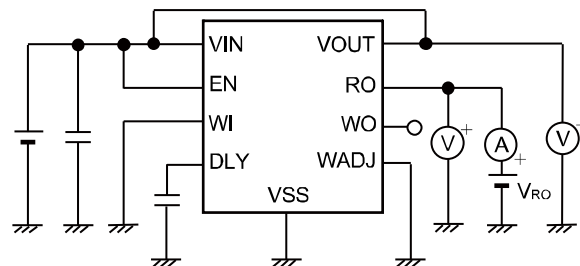

Figure 28 Test Circuit 6

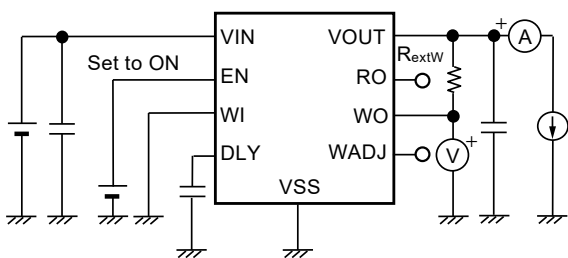

Figure 29 Test Circuit 7

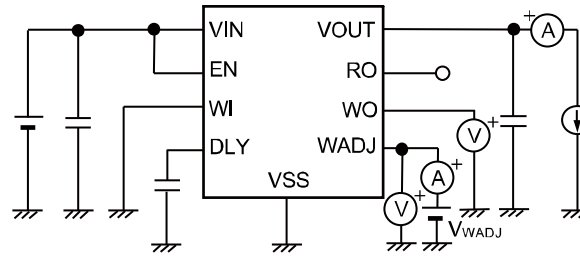

Figure 30 Test Circuit 8

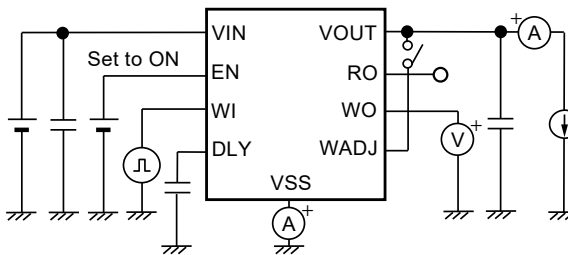

Figure 31 Test Circuit 9

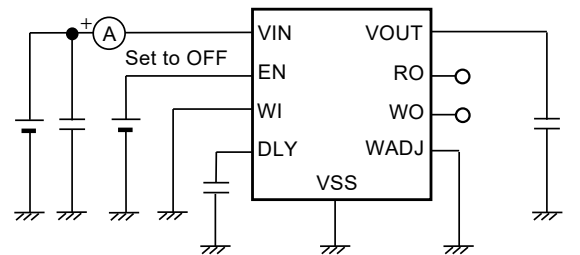

Figure 32 Test Circuit 10

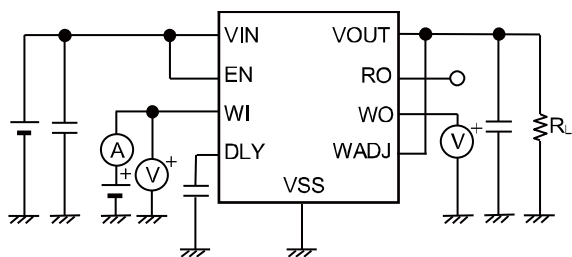

Figure 33 Test Circuit 11

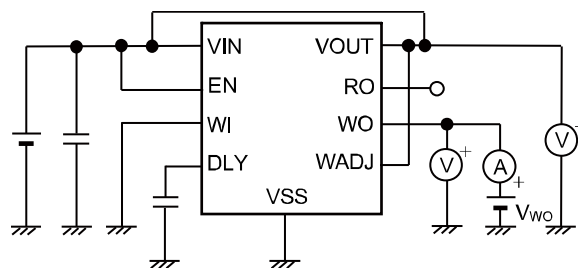

Figure 34 Test Circuit 12

■ Standard Circuits

1. S-19519A/C Series (TO-252-9S package product, HSOP-8A package product)

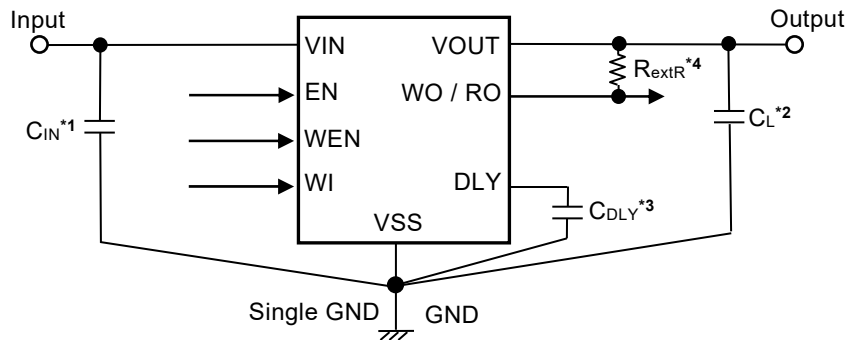

Figure 35

- *1. C_{IN} is a capacitor for stabilizing the input.
- *2. C_L is a capacitor for stabilizing the output.
- *3. C_{DLY} is the release delay time and monitoring time adjustment capacitor.
- *4. Connection of the external pull-up resistor is not absolutely essential since the S-19519 Series has a built-in pull-up resistor.

2. S-19519B Series (HTSSOP-16 package product)

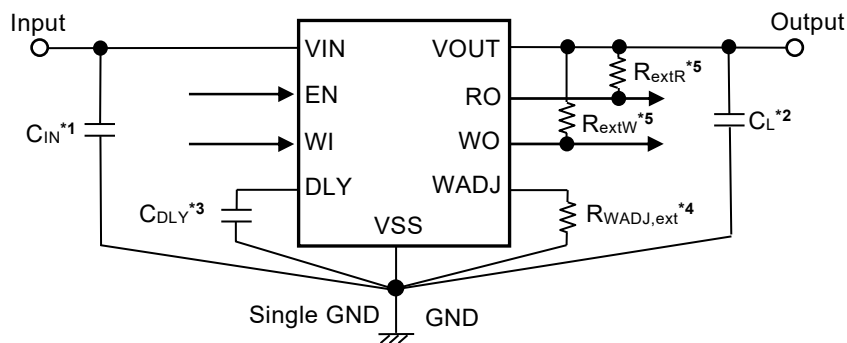

Figure 36

- *1. C_{IN} is a capacitor for stabilizing the input.
- *2. C_L is a capacitor for stabilizing the output.
- *3. C_{DLY} is the release delay time and monitoring time adjustment capacitor.
- *4. $R_{WADJ,ext}$ is the watchdog activation threshold current adjustment resistor.
- *5. R_{extR} and R_{extW} are the external pull-up resistors for the reset output pin and the watchdog output pin, respectively. Connection of the external pull-up resistor is not absolutely essential since the S-19519 Series has a built-in pull-up resistor.

Caution The above connection diagram and constants will not guarantee successful operation. Perform thorough evaluation using an actual application to set the constants.

■ Selection of External Parts

1. Input and output capacitors (C_{IN}, C_L)

The S-19519 Series requires C_L between the VOUT pin and the VSS pin for phase compensation. Operation is stabilized by a ceramic capacitor with an output capacitance of 1.0 μF or more over the entire temperature range. When using an OS capacitor, a tantalum capacitor, or an aluminum electrolytic capacitor, the capacitance must be 1.0 μF or more, and the ESR must be 100 Ω or less.

The values of output overshoot and undershoot, which are transient response characteristics, vary depending on the value of the output capacitor.

The required value of capacitance for the input capacitor differs depending on the application.

Caution Define the capacitance of C_{IN} and C_L by sufficient evaluation including the temperature characteristics under the actual usage conditions.

2. Release delay time and monitoring time adjustment capacitor (C_{DLY})

In the S-19519 Series, the release delay time and monitoring time adjustment capacitor (C_{DLY}) is necessary between the DLY pin and the VSS pin to adjust the release delay time (t_{rd}) of the detector and the monitoring time of the watchdog timer.

The set release delay time (t_{rd(S)}), the set watchdog trigger time (t_{wi,tr(S)}), the set watchdog output "L" time (t_{wd,L(S)}) and the set watchdog double-pulse detection time (t_{wi,dp(S)}) are calculated by using following equations, respectively.

The release delay time (t_{rd}), the watchdog trigger time (t_{wi,tr}), the watchdog output "L" time (t_{wd,L}) and the watchdog double-pulse detection time (t_{wi,dp}) at the time of the condition of C_{DLY} = 10 nF or C_{DLY} = 3.3 nF are shown in "■ Electrical Characteristics". Use C_{DLY} = 10 nF for calculating t_{wi,tr(S)}, t_{wd,L(S)}, t_{wi,dp(S)}.

$$t_{rd(S)} [\text{ms}] = t_{rd} [\text{ms}] \times \frac{C_{DLY} [\text{nF}]}{10 [\text{nF}]} \quad (\text{S-19519A/B Series})$$

$$t_{rd(S)} [\text{ms}] = t_{rd} [\text{ms}] \times \frac{C_{DLY} [\text{nF}]}{3.3 [\text{nF}]} \quad (\text{S-19519C Series})$$

$$t_{wi,tr(S)} [\text{ms}] = t_{wi,tr} [\text{ms}] \times \frac{C_{DLY} [\text{nF}]}{10 [\text{nF}]}$$

$$t_{wd,L(S)} [\text{ms}] = t_{wd,L} [\text{ms}] \times \frac{C_{DLY} [\text{nF}]}{10 [\text{nF}]}$$

$$t_{wi,dp(S)} [\text{ms}] = t_{wi,dp} [\text{ms}] \times \frac{C_{DLY} [\text{nF}]}{10 [\text{nF}]}$$

- Caution**
1. The above equations will not guarantee successful operation. Perform thorough evaluation including the temperature characteristics using an actual application to set the constants.
 2. Mounted board layout should be made in such a way that no current flows into or flows from the DLY pin since the impedance of the DLY pin is high, otherwise correct delay time and monitoring time may not be provided.
 3. Select C_{DLY} whose leakage current can be ignored against the built-in constant current (0.6 μA typ. (S-19519A/B Series) or 8.0 μA typ. (S-19519C Series)). The leakage current may cause deviation in delay time and monitoring time. When the leakage current is larger than the built-in constant current, no release takes place.
 4. Deviations of C_{DLY} are not included in the equations mentioned above. Be sure to determine the constants considering the deviation of C_{DLY} to be used.

3. Watchdog activation threshold current adjustment resistor (R_{WADJ,ext})

In the S-19519B Series, the watchdog activation threshold current adjustment resistor (R_{WADJ,ext}) can be connected between the WADJ pin and the VSS pin to adjust the watchdog timer activation threshold current.

The set watchdog activation threshold current (I_{o,WDact(S)}), the set watchdog deactivation threshold current (I_{o,WDdeact(S)}) and the set watchdog activation hysteresis current (I_{o,WDhys(s)}) are calculated by using following equations, respectively.

The watchdog activation threshold current (I_{o,WDact}), the watchdog deactivation threshold current (I_{o,WDdeact}) and the watchdog activation hysteresis current (I_{o,WDhys}) when the WADJ pin is open are shown in "■ Electrical Characteristics".

$$I_{o,WDact(S)} [\text{mA}] = I_{o,WDact} [\text{mA}] \times \left(1 + \frac{R_{WADJ,int} [\text{k}\Omega]}{R_{WADJ,ext} [\text{k}\Omega]} \right)$$

$$I_{o,WDdeact(S)} [\text{mA}] = I_{o,WDdeact} [\text{mA}] \times \left(1 + \frac{R_{WADJ,int} [\text{k}\Omega]}{R_{WADJ,ext} [\text{k}\Omega]} \right)$$

$$I_{o,WDhys(S)} [\text{mA}] = I_{o,WDact(S)} [\text{mA}] - I_{o,WDdeact(S)} [\text{mA}]$$

- Caution 1. The above equations will not guarantee successful operation. Perform thorough evaluation including the temperature characteristics using an actual application to set the constants.
2. Mounted board layout should be made in such a way that no current flows into or flows from the WADJ pin since the impedance of the WADJ pin is high, otherwise correct $I_{O,WDact}$ and $I_{O,WDdeact}$ may not be provided.
 3. Refer to "3. 2. 2 Autonomous watchdog operation function (Output current detection circuit)" in "■ Operation" for the details.

■ Operation

1. Regulator block

1.1 Basic operation

Figure 37 shows the block diagram of the regulator in the S-19519 Series.

The error amplifier compares the reference voltage (V_{ref}) with feedback voltage (V_{fb}), which is the output voltage resistance-divided by feedback resistors (R_s and R_f). It supplies the gate voltage necessary to maintain the constant output voltage which is not influenced by the input voltage and temperature change, to the output transistor.

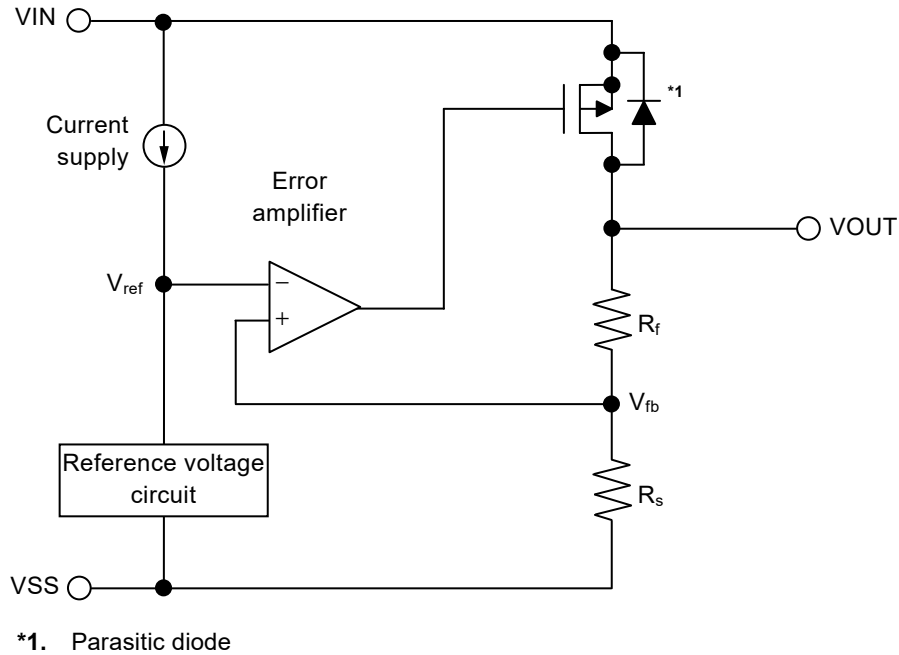

Figure 37

1.2 Output transistor

In the S-19519 Series, a low on-resistance P-channel MOS FET is used as the output transistor.

Be sure that V_{OUT} does not exceed $V_{IN} + 0.3$ V to prevent the voltage regulator from being damaged due to reverse current flowing from the V_{OUT} pin through a parasitic diode to the V_{IN} pin, when the potential of V_{OUT} became higher than V_{IN} .

1.3 Overcurrent protection circuit

The S-19519 Series includes an overcurrent protection circuit which having the characteristics shown in "1.1 Output voltage vs. Output current (When load current increases) (Ta = +25°C)" of "1. Regulator block" in "■ Characteristics (Typical Data)", in order to limit an excessive output current and overcurrent of the output transistor due to short-circuiting between the VOUT pin and the VSS pin. The current when the output pin is short-circuited (I_{short}) is internally set at 160 mA typ., and the load current when short-circuiting is limited based on this value. The output voltage restarts regulating if the output transistor is released from overcurrent status.

Caution This overcurrent protection circuit does not work as for thermal protection. If this IC long keeps short circuiting, pay attention to the conditions of input voltage and load current so that, under the usage conditions including short circuit, the loss of the IC will not exceed power dissipation.

1.4 Thermal shutdown circuit

The S-19519 Series has a thermal shutdown circuit to limit self-heating. When the junction temperature rises to 170°C typ., the thermal shutdown circuit operates to stop regulating. After that, when the junction temperature drops to 135°C typ., the thermal shutdown circuit is released to restart regulating.

Due to self-heating of the S-19519 Series, if the thermal shutdown circuit starts operating, it stops regulating so that the output voltage drops. For this reason, self-heating is limited and the IC's temperature drops.

When the temperature drops, the thermal shutdown circuit is released to restart regulating, thus self-heating is generated again due to rising of the output voltage. Repeating this procedure makes the waveform of the VOUT pin output into a pulse-like form. This phenomenon continues unless decreasing either or both of the input voltage and the output current in order to reduce the internal power consumption or decreasing the ambient temperature. Note that the product may suffer physical damage such as deterioration if the above phenomenon occurs continuously.

Table 18

Thermal Shutdown Circuit	VOUT Pin Voltage
Detect: 170°C typ.*1	V _{SS} level
Release: 135°C typ.*1	Set value

*1. Junction temperature

1.5 ON / OFF circuit

The ON / OFF circuit controls the internal circuit and the output transistor in order to start and stop the regulator. When the EN pin is set to "L" (OFF), the internal circuit stops operating and the output transistor between the VIN pin and the VOUT pin is turned off, reducing current consumption significantly.

The internal equivalent circuit related to the EN pin is configured as shown in **Figure 38**. Since the EN pin is internally pulled down by the constant current source, the EN pin is set to "L" if it is used in the floating status, and the output transistor is turned off. However, in order that the EN pin becomes OFF certainly, connect the EN pin to GND so that "L" is certainly input to the EN pin, since the impedance of the EN pin becomes high when using the EN pin in the floating status.

When not using the EN pin, connect it to the VIN pin. Note that the current consumption increases when an intermediate voltage is applied to the EN pin.

Table 19

EN Pin	Internal Circuit	VOUT Pin Voltage	Current Consumption
"H": ON	Operate	Constant value*1	I _{SS1}
"L": OFF	Stop	Pulled down to V _{SS} *2	I _{SS2}

*1. The constant value is output due to the regulating based on the set output voltage value.

*2. The VOUT pin voltage is pulled down to V_{SS} due to combined resistance (R_{LOW} = 1.2 kΩ typ.) of the discharge shunt circuit and the feedback resistors, and a load.

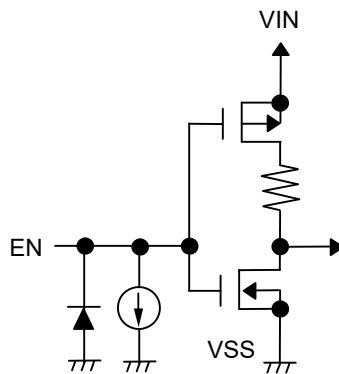

Figure 38

2. Detector block

2.1 Basic operation

- (1) When the output voltage (V_{OUT}) of the regulator is release voltage ($+V_{DET}$) of the detector or higher, the Nch transistor (N1 and N2) are turned off and "H" is output to the RO pin. Since the Pch transistor (P1) is turned on, the input voltage to the comparator (C1) is $\frac{R_B \cdot V_{OUT}}{R_A + R_B}$.
- (2) Even if V_{OUT} decreases to $+V_{DET}$ or lower, "H" is output to the RO pin when V_{OUT} is the detection voltage ($-V_{DET}$) or higher. When V_{OUT} decreases to $-V_{DET}$ (point A in **Figure 40**) or lower, N1 which is controlled by C1 is turned on, and C_{DLY} is discharged. At the same time, N2, which is controlled by the delay circuit, is turned on, and "L" is output to the RO pin. At this time, P1 is turned off, and the input voltage to C1 is $\frac{R_B \cdot V_{OUT}}{R_A + R_B + R_C}$.
- (3) If V_{OUT} further decreases to the IC's minimum operation voltage or lower, the RO pin output becomes uncertain. If the RO pin is pulled up, "H" is output.
- (4) When V_{OUT} increases to the IC's minimum operation voltage or higher, "L" is output to the RO pin. Moreover, even if V_{OUT} exceeds $-V_{DET}$, the output is "L" when V_{OUT} is lower than $+V_{DET}$.
- (5) When V_{OUT} increases to $+V_{DET}$ (point B in **Figure 40**) or higher, N1 is turned off and C_{DLY} is charged. When V_{DLY} increases to the threshold voltage (1.25 V typ.), N2, which is controlled by a delay circuit, is turned off and "H" is output to the RO pin.

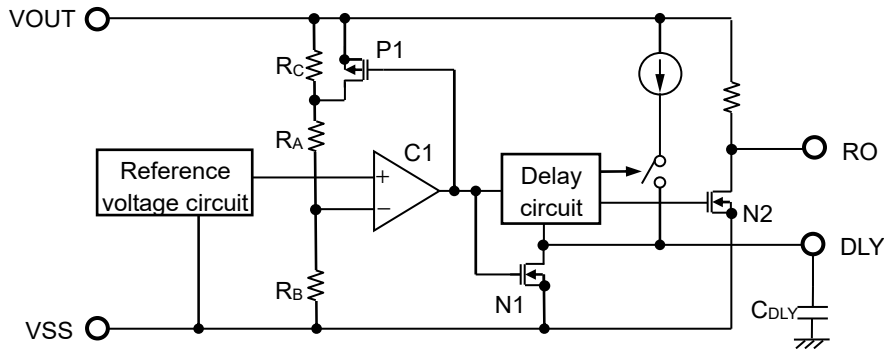

Figure 39 Operation of Detector Block

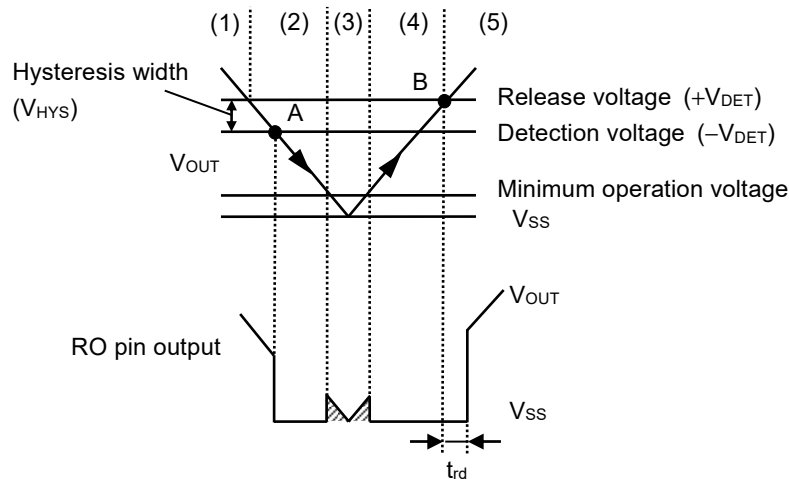

Figure 40 Timing Chart of Detector Block

2.2 Delay circuit

When the output voltage (V_{OUT}) of the regulator rises under the status that "L" is output to the RO pin, the reset release signal is output to the RO pin later than when V_{OUT} becomes $+V_{DET}$. The release delay time (t_{rd}) changes according to C_{DLY} . Refer to "2. Release delay time and monitoring time adjustment capacitor (C_{DLY})" in "■ Selection of External Parts" for details.

In addition, if the time from when V_{OUT} decreases to $-V_{DET}$ or lower to when V_{OUT} increases to $+V_{DET}$ or higher is significantly shorter compared to the length of the reset reaction time (t_r), "H" output may remain in the RO pin.

Caution Since t_{rd} depends on the charge time of C_{DLY} , t_{rd} may be shorter than the set value if the charge operation is initiated under the condition that a residual electric charge is left in C_{DLY} .

2.3 Output circuit

Since the RO pin has a built-in resistor to pull up to the VOUT pin internally, the RO pin can output a signal without an external pull-up resistor

Do not connect to the pin other than VOUT pin when connecting an external pull-up resistor.

In the S-19519A/C Series, the reset output pin and the watchdog output pin are prepared as the WO / RO pin.

The output level of the WO / RO pin is applied by the AND logic of the reset output pin and the watchdog output pin.

Example: When the WO pin is "L" and the RO pin is "H", the WO / RO pin is "L".

Caution Define the external pull-up resistance by sufficient evaluation including the temperature characteristics under the actual usage conditions.

3. Watchdog timer block

3.1 S-19519A/C Series (TO-252-9S package product, HSOP-8A package product)

3.1.1 Basic operation

The watchdog timer operates as follows during monitoring operation.

- (1) When the watchdog timer starts monitoring operation, it enters the Open window status, and C_{DLY} charge-discharge operation is carried out by an internal constant current source. If a rising edge is input to the WI pin in the Open window status, the watchdog timer detects a trigger, and switches to the Closed window status. If a trigger is not detected in the Closed window status, the C_{DLY} charge-discharge operation is carried out and if the watchdog double-pulse detection time ($t_{WI,dp}$) is exceeded, the watchdog timer switches to the Open window status. If the watchdog timer again detects a trigger in the Open window status, it switches to the Closed window status. During this time, the WO pin outputs "H". In order to verify the normal operation of the object being monitored, input a rising edge to the WI pin in the Open window status, and do not input a rising edge in the Closed window status.
- (2) While no triggers are detected in the Open window status, the C_{DLY} charge-discharge operation is repeated, and once the watchdog trigger time ($t_{WI,tr}$) elapses after monitoring has started or after the last trigger was detected, the watchdog timer switches to the Watchdog fault status, and the WO pin outputs "L". This operation is called a "time-out detection". If the watchdog timer is deactivated while the WO pin is outputting "H", the number of charges and discharges and $t_{WI,tr}$ elapsed time are reset.
- (3) After a time-out detection, C_{DLY} charge-discharge operation is carried out while the WO pin outputs "L" in the Watchdog fault status. After the watchdog output "L" time ($t_{WD,L}$) has elapsed, the watchdog timer switches to the Open window status and the WO pin outputs "H". Even if the watchdog timer is deactivated while the WO pin is outputting "L", the WO pin continues to output "L" until the $t_{WD,L}$ has elapsed.
- (4) If the watchdog timer detects a trigger in the Open window status, it switches to the Closed window status, and if a trigger is detected again before the $t_{WI,dp}$ elapses, the watchdog timer switches to the Watchdog fault status, and the WO pin outputs "L". This operation is called a "double-pulse detection".
- (5) After a double-pulse detection, C_{DLY} charge-discharge operation is carried out while the WO pin outputs "L" in the Watchdog fault status. As with the case of (3), when $t_{WD,L}$ elapses, the watchdog timer switches to the Open window status and the WO pin outputs "H".
- (6) After the watchdog timer reverts back to the Open window status from the Watchdog fault status, operation (1), (2), or (4) is continually carried out depending on input.

Refer to **Figure 41** for the status transition of watchdog timer block.

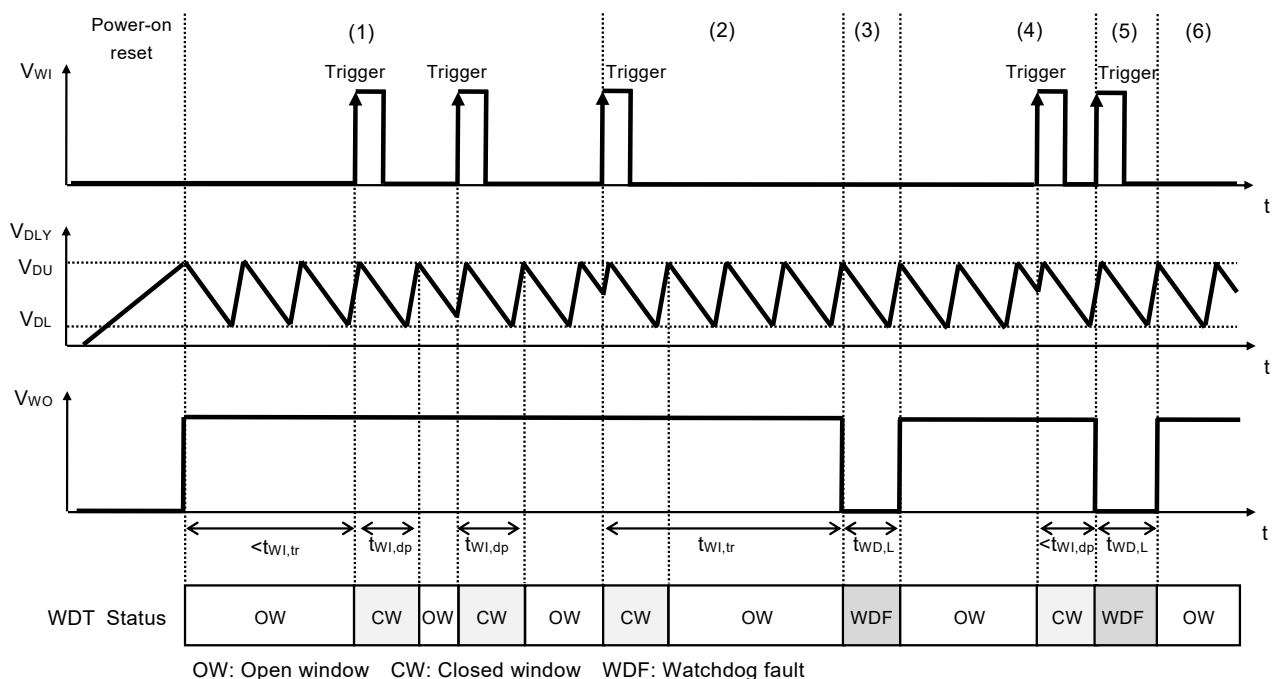

Figure 41 Timing Chart of Watchdog Timer Block

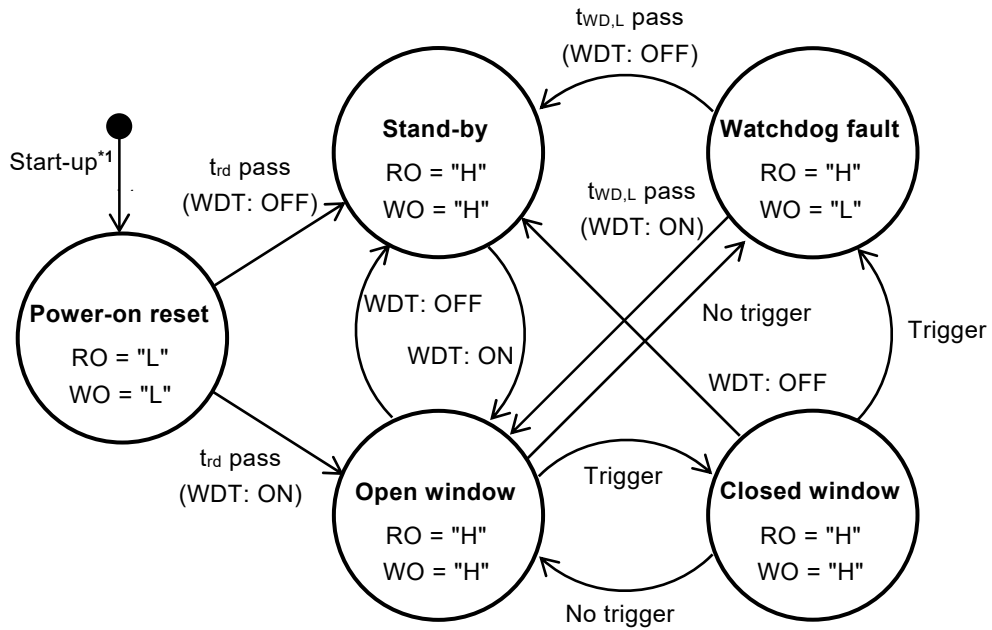

Figure 42 Status Transition of Watchdog Timer Block

*1. If the detector block detects low voltage as a result of V_{OUT} dropping below the detection voltage ($-V_{DET}$), the watchdog timer resets to the initial status. If V_{OUT} is restored and exceeds the release voltage ($+V_{DET}$), the watchdog timer is activated and switches to the Power-on reset status.

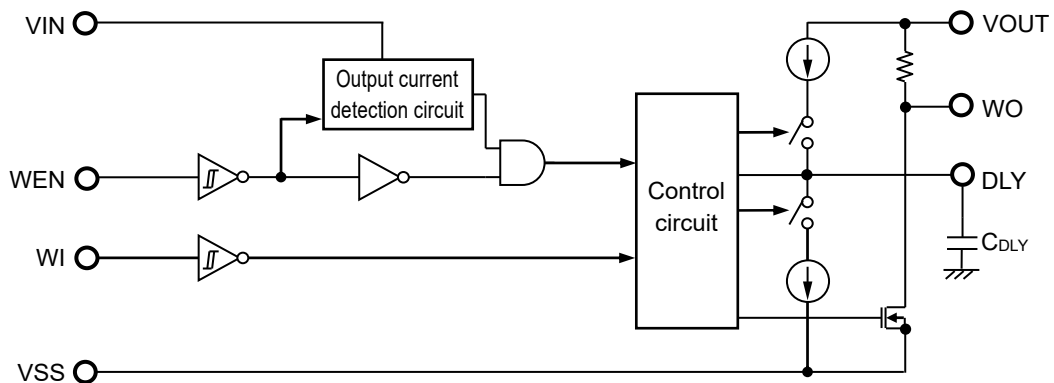

Figure 43 Operation of Watchdog Timer Block

3. 1. 2 Autonomous watchdog operation function (Output current detection circuit)

Since the S-19519A/C Series has a built-in output current detection circuit, the watchdog timer operates autonomously. The current flows in the load is detected by the output current of the regulator, the watchdog timer initiates the activation when the output current is the watchdog activation threshold current ($I_{O,WDact}$) or more, the watchdog timer is deactivated when the output current is the watchdog deactivation threshold current ($I_{O,WDdeact}$) or less.

Figure 44 shows a block diagram which includes an output current detection circuit. If the regulator is connected to a microcontroller, the microcontroller operation current can be detected using the regulator output current. For example, if the microcontroller sleep operation current is lower than the watchdog deactivation threshold current ($I_{O,WDdeact}$), the watchdog timer autonomously deactivates monitoring operation when the microcontroller sleeps. If the VIN pin voltage drops below the output current detection circuit minimum operation voltage, the output current detection circuit stops the operation. Refer to "■ Recommended Operation Conditions" for VIN pin voltage range.

In addition, in the S-19519A/C Series, if the watchdog timer is disabled using the WEN pin, the watchdog timer is deactivated regardless of the output current.

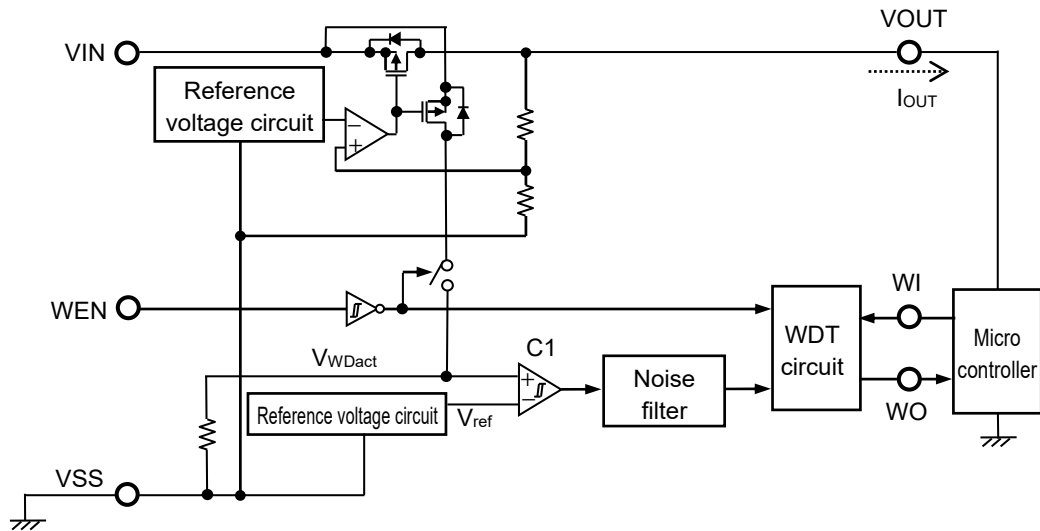

Figure 44 Operation of Output Current Detection Circuit

Caution Microcontroller is not built-in in the S-19519A/C Series. In addition, the above connection diagram will not guarantee successful operation. Perform thorough evaluation using the actual application to determine connections.

Since the S-19519A/C Series has the autonomous watchdog operation function, the watchdog timer monitoring activation is as follows.

- (1) When I_{OUT} of the regulator is the watchdog activation threshold current ($I_{O,WDact}$) or more, the input voltage (V_{WDact}) of comparator (C1) is higher than the reference voltage (V_{ref}), and the output of C1 is "H". At this time, the watchdog timer activated.
- (2) When I_{OUT} decreases to the watchdog deactivation threshold current ($I_{O,WDdeact}$) (point A in **Figure 45**) or less, V_{WDact} decreases to V_{ref} or less and the output of C1 is "L". At this time, the watchdog timer deactivates the monitoring. Even if I_{OUT} increases, the watchdog timer continues the monitoring deactivation when I_{OUT} is within less than $I_{O,WDact}$.
- (3) If I_{OUT} further increases to $I_{O,WDact}$ (point B in **Figure 45**) or more, V_{WDact} increases to V_{ref} or higher and the output of C1 is "H". And then, the watchdog timer initiates the monitoring activation.

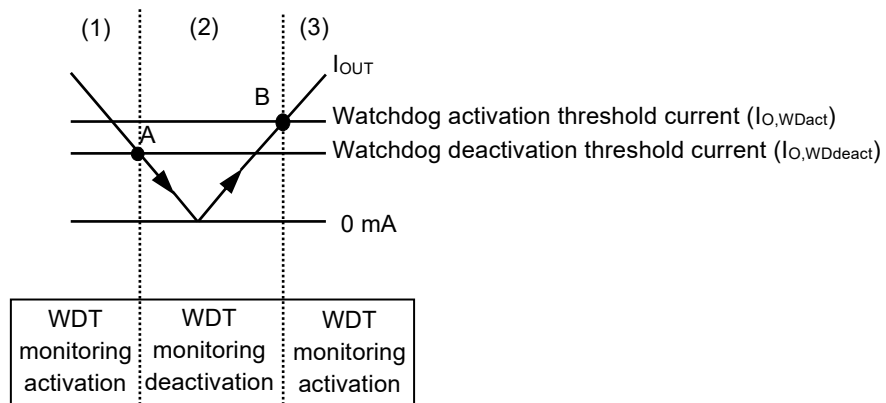

Figure 45 Autonomous Watchdog Operation Function

Caution If the output current of regulator transiently changes, the monitoring activation of watchdog timer may become unstable, resulting in switching between activation and deactivation. Regarding the activation at that time, perform thorough evaluation using an actual application.

3. 1. 3 Watchdog enable circuit

When inputting "L" to the WEN pin, the watchdog timer becomes Disable and stops the output current detection operation and monitoring activation. When inputting "H" to the WEN pin, the watchdog timer becomes Enable. The WEN pin is pulled down internally by the constant current source. For this reason, the WEN pin is set to "L" when using the WEN pin in the floating status, and the watchdog timer becomes Disable. However, in order that the watchdog timer becomes Disable certainly, connect the WEN pin to GND so that "L" is input to the WEN pin certainly, since the impedance of the WEN pin becomes high when using the WEN pin in the floating status. In order to fix the watchdog timer to Enable, connect the WEN pin to the VOUT pin so that "H" is input to the WEN pin.

Table 20 shows the relation between each pin status and the watchdog timer monitoring operation.

Table 20

WEN Pin	Output Current*1	VOUT Pin Voltage	WDT Monitoring Operation
"H"	"H"	$\geq +V_{DET}$	ON
"H"	"L"	$\geq +V_{DET}$	OFF
"L"	Don't care	$\geq +V_{DET}$	OFF
Don't care	Don't care	$\leq -V_{DET}$	OFF

*1. "H": $I_{OUT} > I_{O,WDact}$, "L": $I_{OUT} < I_{O,WDdeact}$

3.2 S-19519B Series (HTSSOP-16 package product)

3.2.1 Basic operation

The watchdog timer operates as follows during monitoring operation.

- (1) When the watchdog timer starts monitoring operation, it enters the Open window status, and C_{DLY} charge-discharge operation is carried out by an internal constant current source. If a rising edge is input to the WI pin in the Open window status, the watchdog timer detects a trigger, and switches to the Closed window status. If a trigger is not detected in the Closed window status, the C_{DLY} charge-discharge operation is carried out and if the watchdog double-pulse detection time ($t_{WI,dp}$) is exceeded, the watchdog timer switches to the Open window status. If the watchdog timer again detects a trigger in the Open window status, it switches to the Closed window status. During this time, the WO pin outputs "H". In order to verify the normal operation of the object being monitored, input a rising edge to the WI pin in the Open window status, and do not input a rising edge in the Closed window status.
- (2) While no triggers are detected in the Open window status, the C_{DLY} charge-discharge operation is repeated, and once the watchdog trigger time ($t_{WI,tr}$) elapses after monitoring has started or after the last trigger was detected, the watchdog timer switches to the Watchdog fault status, and the WO pin outputs "L". This operation is called a "time-out detection". If the watchdog timer is deactivated while the WO pin is outputting "H", the number of charges and discharges and $t_{WI,tr}$ elapsed time are reset.
- (3) After a time-out detection, C_{DLY} charge-discharge operation is carried out while the WO pin outputs "L" in the Watchdog fault status. After the watchdog output "L" time ($t_{WD,L}$) has elapsed, the watchdog timer switches to the Open window status and the WO pin outputs "H". Even if the watchdog timer is deactivated while the WO pin is outputting "L", the WO pin continues to output "L" until the $t_{WD,L}$ has elapsed.
- (4) If the watchdog timer detects a trigger in the Open window status, it switches to the Closed window status, and if a trigger is detected again before the $t_{WI,dp}$ elapses, the watchdog timer switches to the Watchdog fault status, and the WO pin outputs "L". This operation is called a "double-pulse detection".
- (5) After a double-pulse detection, C_{DLY} charge-discharge operation is carried out while the WO pin outputs "L" in the Watchdog fault status. As with the case of (3), when $t_{WD,L}$ elapses, the watchdog timer switches to the Open window status and the WO pin outputs "H".
- (6) After the watchdog timer reverts back to the Open window status from the Watchdog fault status, operation (1), (2), or (4) is continually carried out depending on input.

Refer to **Figure 46** for the status transition of watchdog timer block.

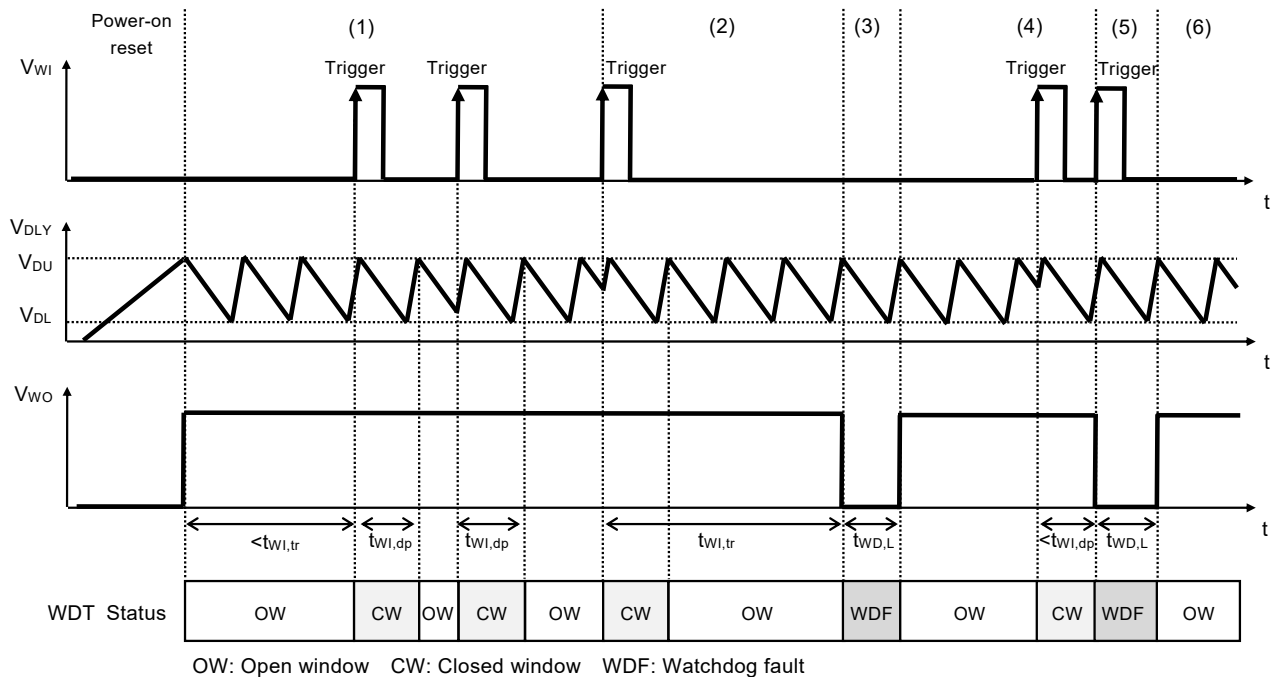

Figure 46 Timing Chart of Watchdog Timer Block

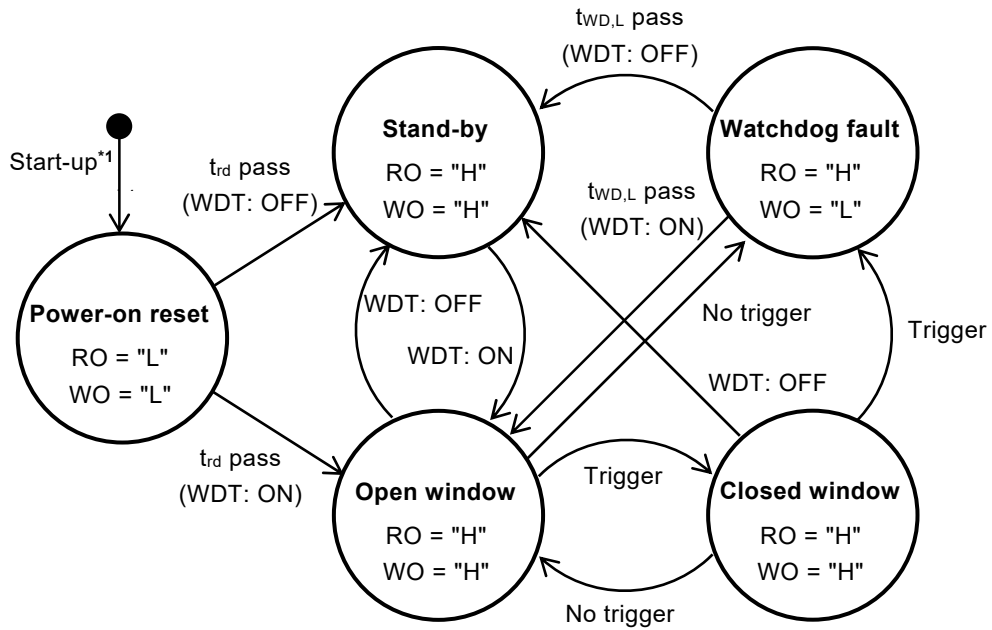

Figure 47 Status Transition of Watchdog Timer Block

*1. If the detector block detects low voltage as a result of V_{OUT} dropping below the detection voltage ($-V_{DET}$), the watchdog timer resets to the initial status. If V_{OUT} is restored and exceeds the release voltage ($+V_{DET}$), the watchdog timer is activated and switches to the Power-on reset status.

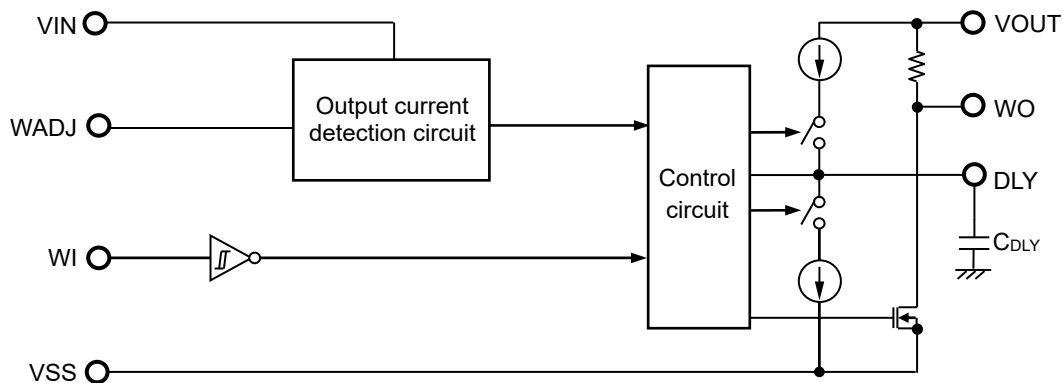

Figure 48 Operation of Watchdog Timer Block

3. 2. 2 Autonomous watchdog operation function (Output current detection circuit)

Since the S-19519B Series has a built-in output current detection circuit, the watchdog timer operates autonomously. When using the autonomous watchdog operation function, the current flows in the load is detected by the output current of the regulator, the watchdog timer initiates the activation when the output current is the watchdog activation threshold current ($I_{O,WDact}$) or more, the watchdog timer is deactivated when the output current is the watchdog deactivation threshold current ($I_{O,WDdeact}$) or less.

Table 21 shows the connection of WADJ pin depending on the usage of the watchdog timer.

Usage of Watchdog Timer	Connection of WADJ Pin	Status of WADJ Pin
Watchdog timer is not in use	Connect to the VSS pin	"L"
Watchdog timer is always activated	Connect to the VOUT pin	"H"
Watchdog timer turns on and off autonomously depending on the load current (Autonomous watchdog operation function)	Open or connect to the VSS pin via an external resistor*1	"H": $I_{OUT} > I_{O,WDact}$ "L": $I_{OUT} < I_{O,WDdeact}$

*1. Refer to "3. Watchdog activation threshold current adjustment resistor ($R_{WADJ,ext}$)" in "■ Selection of External Parts" for details.

Figure 49 shows a block diagram which includes an output current detection circuit. It shows the connection of each pin when using the autonomous watchdog operation function. If the regulator is connected to a microcontroller, the microcontroller operation current can be detected using the regulator output current. For example, if a constant of the watchdog activation threshold current adjustment resistor ($R_{WADJ,ext}$) is selected so that the microcontroller sleep operation current is lower than the watchdog deactivation threshold current ($I_{O,WDdeact}$), when the microcontroller sleeps, the watchdog timer autonomously deactivates monitoring operation. If a device other than a microcontroller is connected to the VOUT pin, take the connected device's current consumption into account when selecting $R_{WADJ,ext}$.

If the VIN pin voltage drops below the output current detection circuit minimum operation voltage, the output current detection circuit stops the operation. Refer to "■ Recommended Operation Conditions" for VIN pin voltage range.

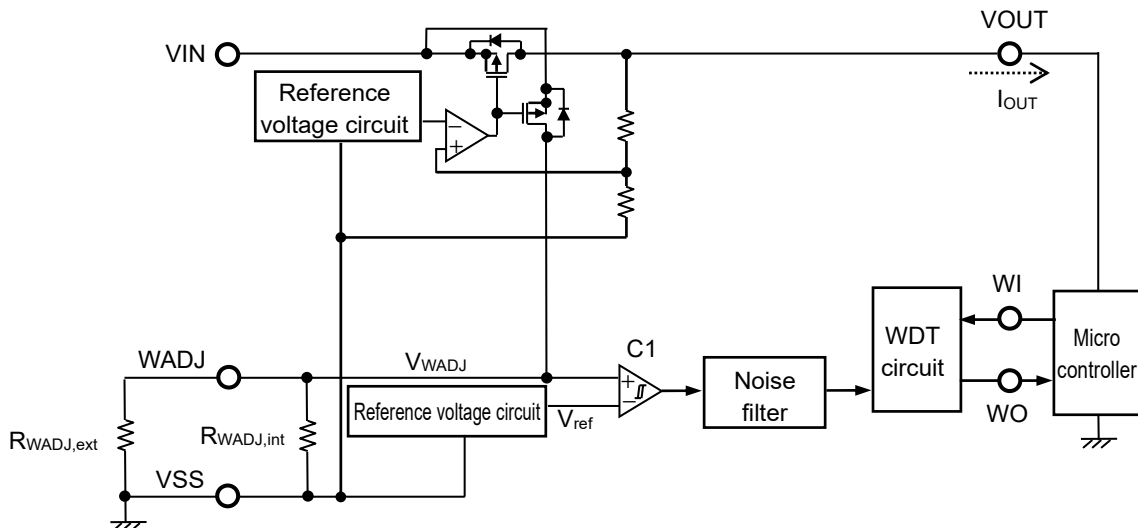

Figure 49 Operation of Output current Detection Circuit

Caution $R_{WADJ,ext}$ and microcontroller are not built-in in the S-19519B Series. In addition, the above connection diagram will not guarantee successful operation. Perform thorough evaluation using the actual application to determine connections.

In the S-19519B Series, when using the autonomous watchdog operation function, the watchdog timer monitoring activation is as follows.

- (1) When I_{OUT} of the regulator is the watchdog activation threshold current ($I_{O,WDact}$) or more, the WADJ pin voltage (V_{WADJ}) is higher than the reference voltage (V_{ref}), and the output of the comparator (C1) is "H". At this time, the watchdog timer is activated.
- (2) When I_{OUT} decreases to the watchdog deactivation threshold current ($I_{O,WDdeact}$) (point A in **Figure 50**) or less, V_{WADJ} decreases to V_{ref} or less and the output of C1 is "L". At this time, the watchdog timer deactivates the monitoring. Even if I_{OUT} increases, the watchdog timer continues the monitoring deactivation when I_{OUT} is within less than $I_{O,WDact}$.
- (3) If I_{OUT} further increases to $I_{O,WDact}$ (point B in **Figure 50**) or more, V_{WADJ} increases to V_{ref} or higher and the output of C1 is "H". And then, the watchdog timer initiates the monitoring activation.

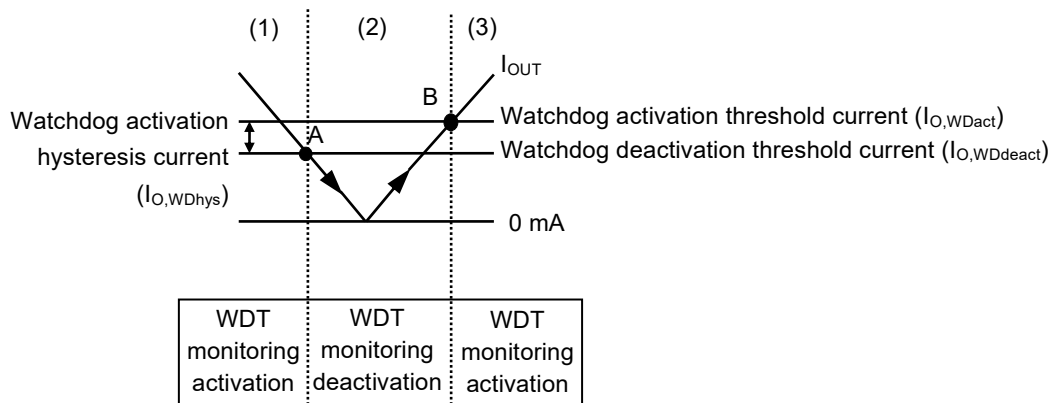

Figure 50 Autonomous Watchdog Operation Function

Caution Due to detecting I_{OUT} of the regulator, current flows through the resistors connected to the WADJ pin ($R_{WADJ,ext}$ and $R_{WADJ,int}$). Therefore, the WADJ pin voltage (V_{WADJ}) may fluctuate since the current flowing through $R_{WADJ,ext}$ and $R_{WADJ,int}$ also changes in the same way if the output current changes transiently. V_{WADJ} at that time should be evaluated with the actual device.

3.3 Watchdog input circuit

By inputting a rising edge to the WI pin, the watchdog timer detects a trigger. Refer to "■ Recommended Operation Conditions" for the input conditions of the signal to be input from the watchdog timer monitored object to the WI pin.

The WI pin is pulled down internally by a constant current source. For this reason, if the WI pin is used in a floating status, the WI pin sets to "L".

Note that if any voltage other than "L" or "H" is input to the WI pin, the current consumption increases.

Triggers are detected only when the WO pin is outputting "H" and C_{DLY} charge-discharge operation is being carried out while the watchdog timer is carrying out monitoring operation.

Caution Under a noisy environment, the watchdog input circuit may detect the noise as a trigger signal. Sufficiently evaluate with the actual application to confirm that a trigger is detected only in the intended signal.

3.4 Watchdog output circuit

Since the WO pin has a built-in resistor to pull up to the VOUT pin internally, the WO pin can output a signal without an external pull-up resistor

Do not connect to the pin other than VOUT pin when connecting an external pull-up resistor.

In the S-19519A Series, the reset output pin and the watchdog output pin are prepared as the WO / RO pin.

The output level of the WO / RO pin is applied by the AND logic of the reset output pin and the watchdog output pin.

Example: When the WO pin is "L" and the RO pin is "H", the WO / RO pin is "L".

Caution Define the external pull-up resistance by sufficient evaluation including the temperature characteristics under the actual usage conditions.

3.5 Each pin status and the watchdog timer monitoring operation

3.5.1 S-19519A/C Series (TO-252-9S package product, HSOP-8A package product)

Table 22

WDT	VOUT Pin Voltage	WDT Monitoring Operation
Enable (WEN = "H")	$\geq +V_{DET}$	ON
Disable (WEN = "L")	$\geq +V_{DET}$	OFF
Don't care	$\leq -V_{DET}$	OFF

3.5.2 S-19519B Series (HTSSOP-16 package product)

Table 23

WADJ Status	VOUT Pin Voltage	WDT Monitoring Operation
"H"	$\geq +V_{DET}$	ON
"L"	$\geq +V_{DET}$	OFF
Don't care	$\leq -V_{DET}$	OFF

■ **Timing Charts**

1. **S-19519A Series (TO-252-9S package product, HSOP-8A package product)**

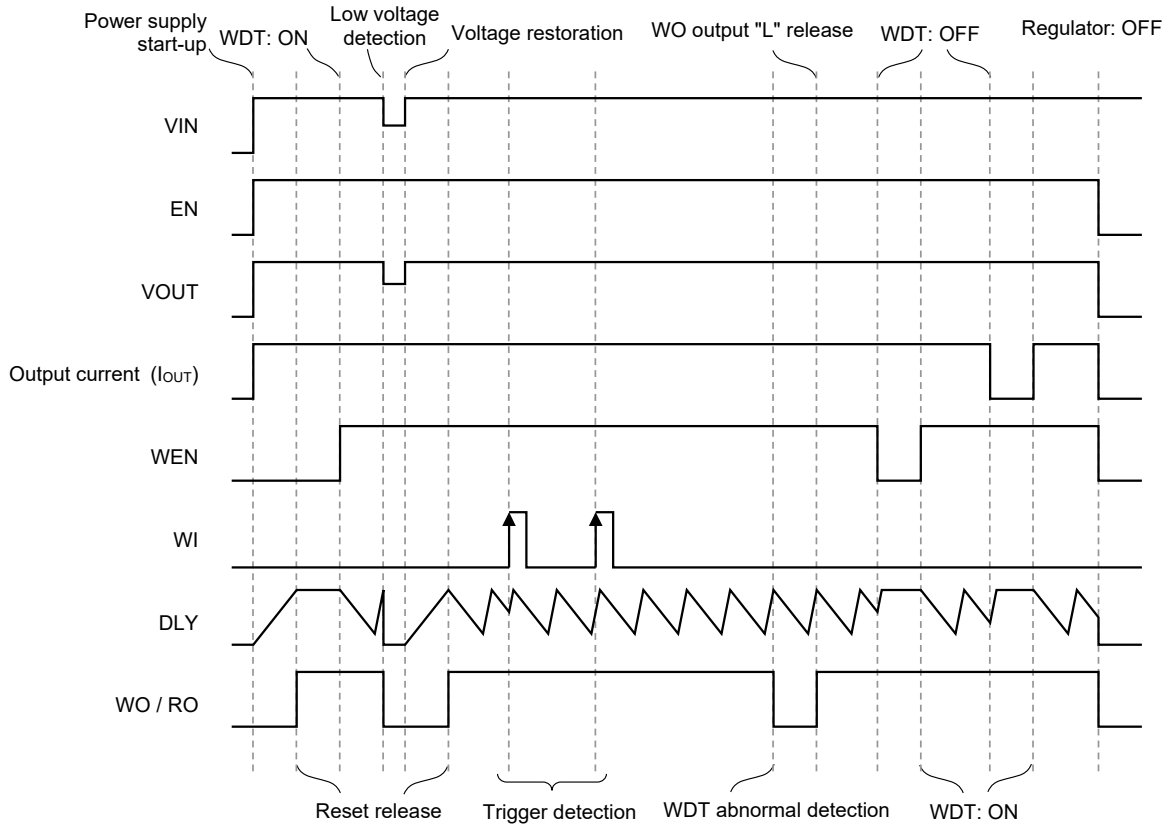

Figure 51

2. **S-19519B Series (HTSSOP-16 package product)**

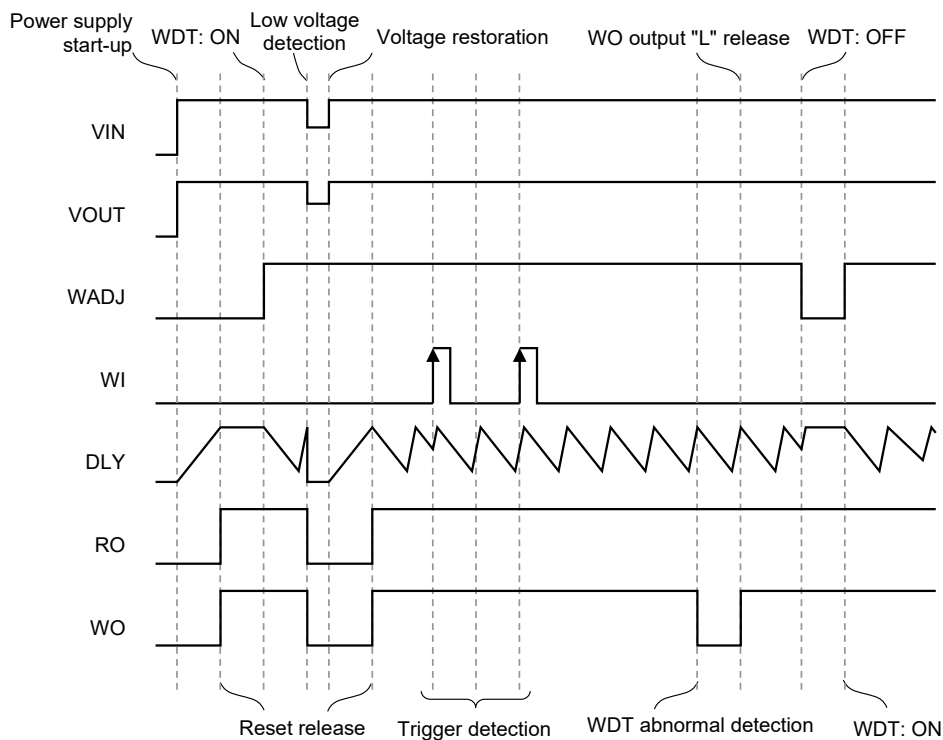

Figure 52

3. S-19519C Series (TO-252-9S package product, HSOP-8A package product)

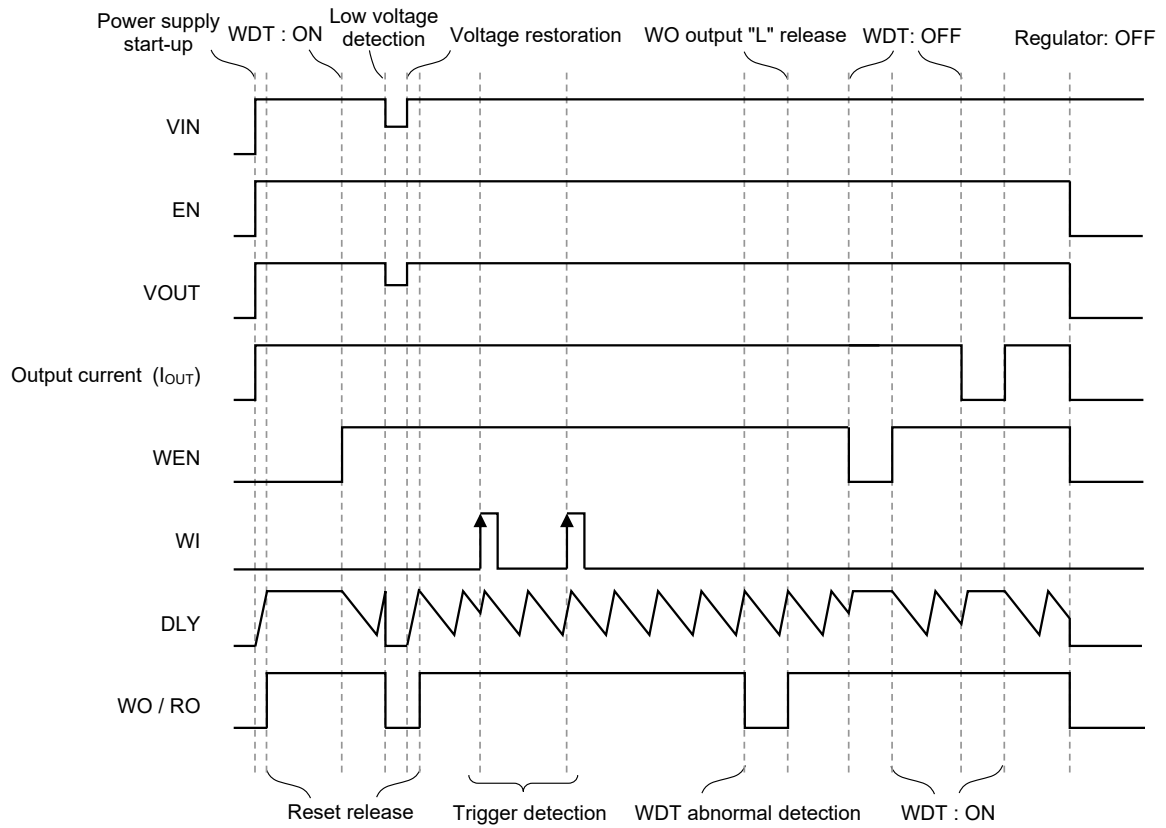

Figure 53

■ Precautions

- Wiring patterns for the VIN pin, the VOUT pin and GND should be designed so that the impedance is low. When mounting an output capacitor between the VOUT pin and the VSS pin (C_L) and an input capacitor between the VIN pin and the VSS pin (C_{IN}), the distance from the capacitors to these pins should be as short as possible.
- Note that generally the output voltage may increase when a series regulator is used at low load current (0.1 mA or less).
- Note that generally the output voltage may increase due to the leakage current from an output transistor when a series regulator is used at high temperature.
- Generally a series regulator may cause oscillation, depending on the selection of external parts. The following conditions are recommended for the S-19519 Series. However, be sure to perform sufficient evaluation under the actual usage conditions for selection, including evaluation of temperature characteristics. Refer to "6. Example of equivalent series resistance vs. Output current characteristics ($T_a = -40^\circ\text{C}$ to $+125^\circ\text{C}$)" in "■ Reference Data" for the equivalent series resistance (R_{ESR}) of the output capacitor.

Input capacitor (C_{IN}):	1.0 μF or more
Output capacitor (C_L):	1.0 μF or more

- In a series regulator, generally the values of overshoot and undershoot in the output voltage vary depending on the variation factors of power-on, power supply fluctuation and load fluctuation, or output capacitance. Determine the conditions of the output capacitor after sufficiently evaluating the temperature characteristics of overshoot or undershoot in the output voltage with the actual device.
- The voltage regulator may oscillate when the impedance of the power supply is high and the input capacitance is small or an input capacitor is not connected.
- Overshoot may occur in the output voltage momentarily if the voltage is rapidly raised at power-on or when the power supply fluctuates. Sufficiently evaluate the output voltage at that time with the actual device.
- If the VOUT pin is steeply shorted with GND, a negative voltage exceeding the absolute maximum ratings may occur to the VOUT pin due to resonance of the wiring inductance and the output capacitance in the application. The negative voltage can be limited by inserting a protection diode between the VOUT pin and the VSS pin or inserting a series resistor to the output capacitor.
- The application conditions for the input voltage, the output voltage, and the load current should not exceed the power dissipation.
- Do not apply an electrostatic discharge to this IC that exceeds the performance ratings of the built-in electrostatic protection circuit.
- In determining the output current, attention should be paid to the output current value specified in **Table 13** in "■ Electrical Characteristics" and footnote *7 of the table.
- ABLIC Inc. claims no responsibility for any disputes arising out of or in connection with any infringement by products including this IC of patents owned by a third party.

■ Characteristics (Typical Data)

1. Regulator block

1.1 Output voltage vs. Output current (When load current increases) ($T_a = +25^\circ\text{C}$)

1.1.1 $V_{\text{OUT}} = 3.3\text{ V}$

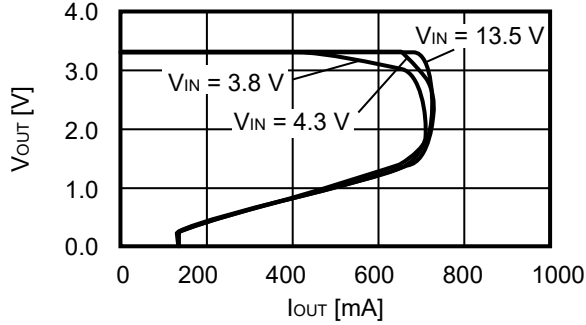

1.1.2 $V_{\text{OUT}} = 5.0\text{ V}$

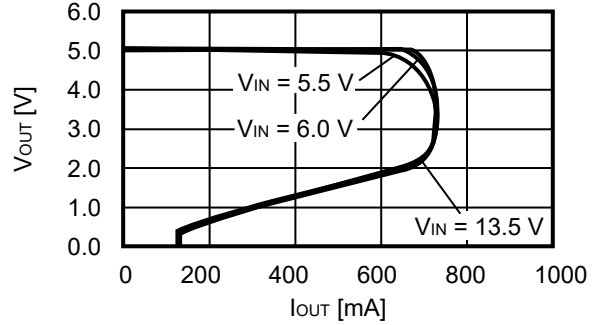

1.2 Output voltage vs. Input voltage ($T_a = +25^\circ\text{C}$)

1.2.1 $V_{\text{OUT}} = 3.3\text{ V}$

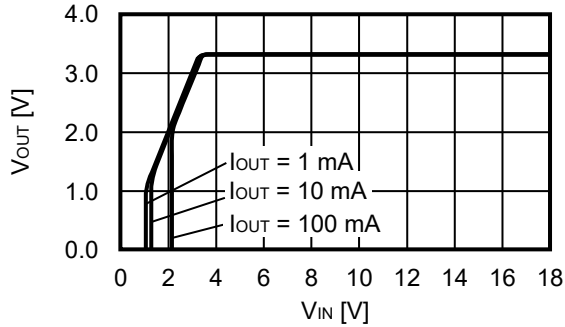

1.2.2 $V_{\text{OUT}} = 5.0\text{ V}$

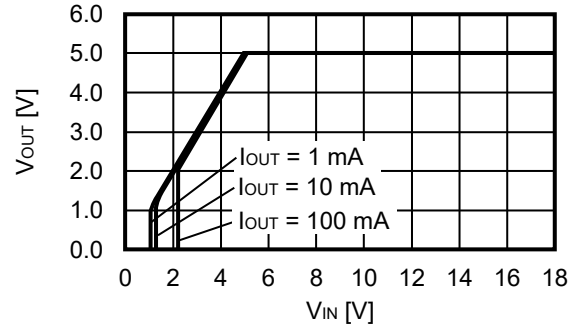

1.3 Dropout voltage vs. Output current

1.3.1 $V_{\text{OUT}} = 3.3\text{ V}$

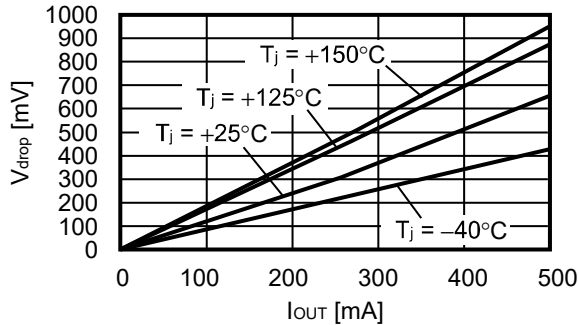

1.3.2 $V_{\text{OUT}} = 5.0\text{ V}$

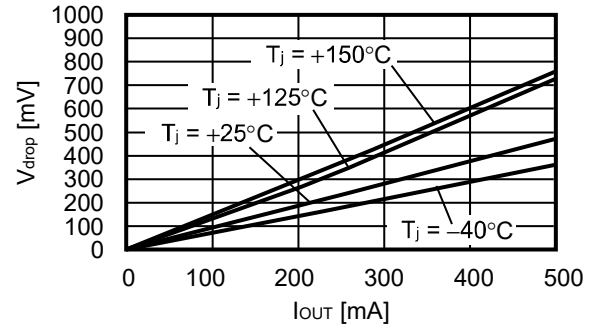

1.4 Dropout voltage vs. Junction temperature

1.4.1 $V_{\text{OUT}} = 3.3\text{ V}$

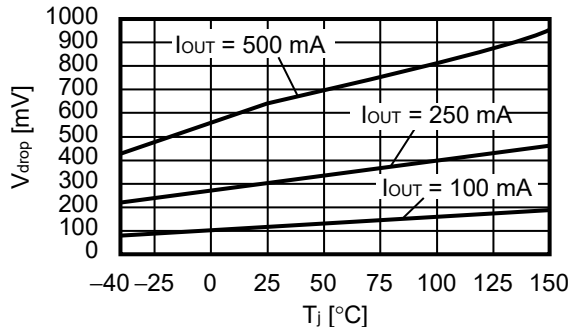

1.4.2 $V_{\text{OUT}} = 5.0\text{ V}$

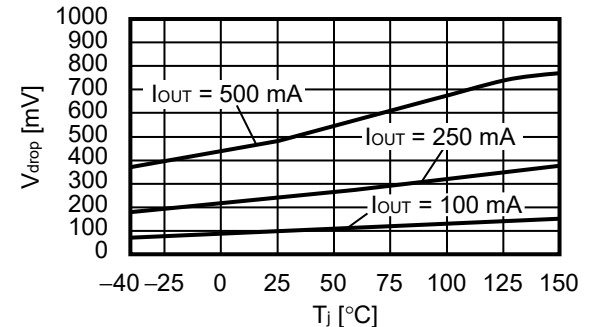

1.5 Output voltage vs. Junction temperature

1.5.1 $V_{OUT} = 3.3\text{ V}$

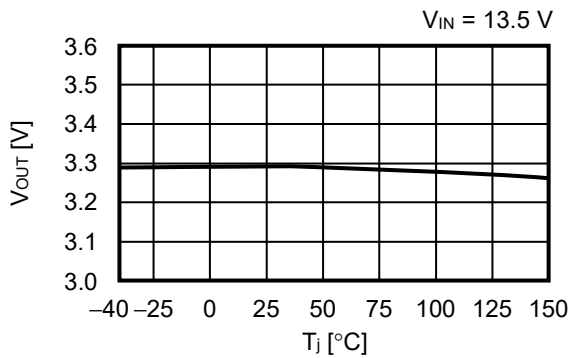

1.5.2 $V_{OUT} = 5.0\text{ V}$

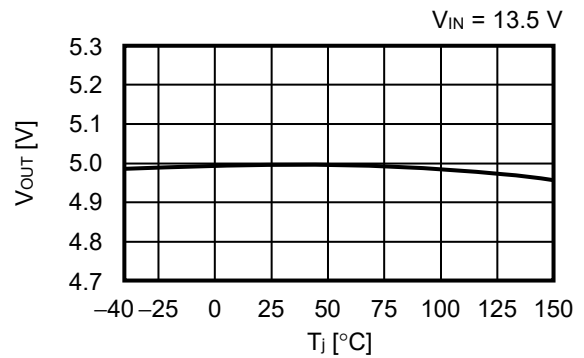

1.6 Ripple rejection ($T_a = +25^\circ\text{C}$)

1.6.1 $V_{OUT} = 3.3\text{ V}$

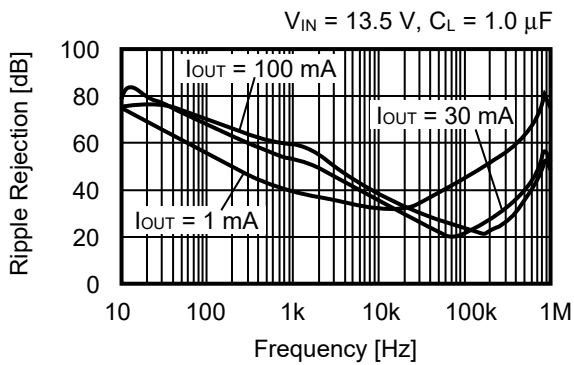

1.6.2 $V_{OUT} = 5.0\text{ V}$

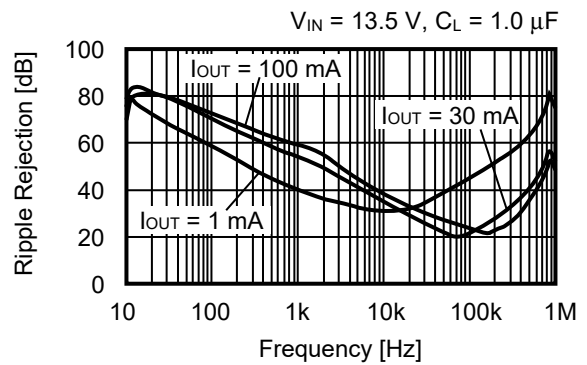

2. Detector block

2.1 Detection voltage, Release voltage vs. Junction temperature

2.1.1 $-V_{DET} = 2.6\text{ V}$

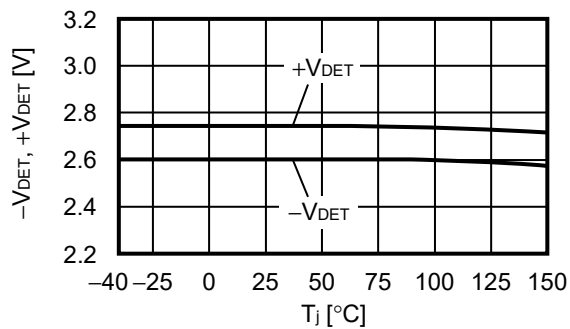

2.1.2 $-V_{DET} = 4.7\text{ V}$

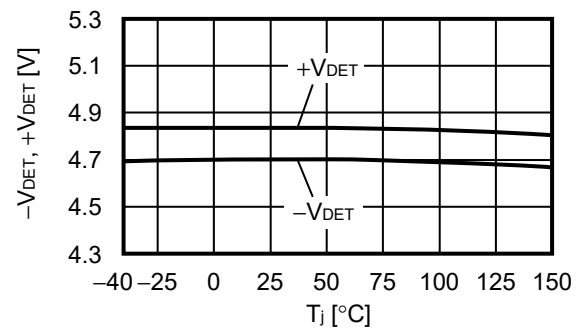

2.2 Hysteresis width vs. Junction temperature

2.2.1 $-V_{DET} = 2.6\text{ V}$

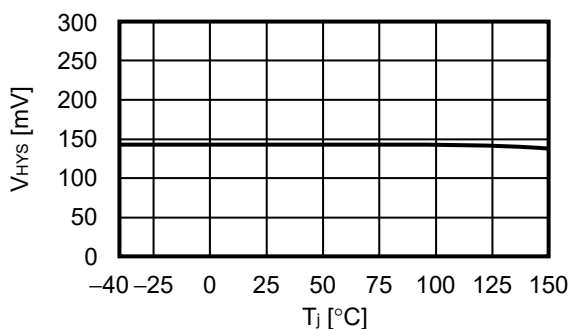

2.2.2 $-V_{DET} = 4.7\text{ V}$

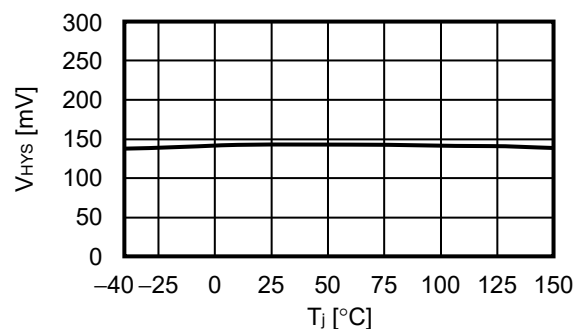

2.3 Reset output current vs. V_{DS}

2.3.1 $-V_{DET} = 2.6\text{ V}$

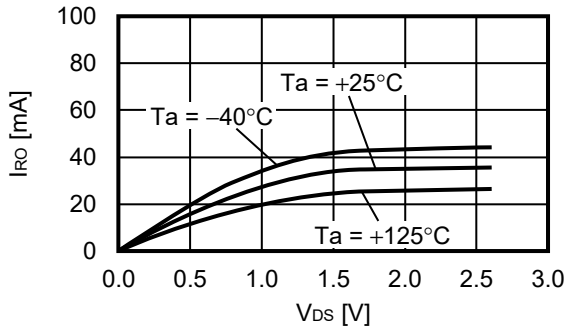

2.3.2 $-V_{DET} = 4.7\text{ V}$

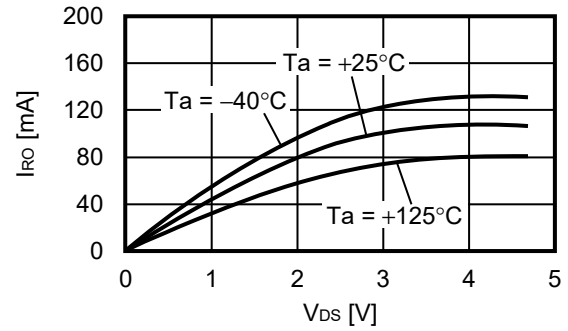

2.4 Reset output current vs. Output voltage

2.4.1 $-V_{DET} = 2.6\text{ V}$

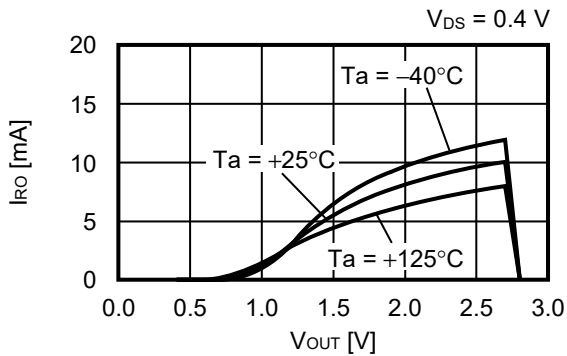

2.4.2 $-V_{DET} = 4.7\text{ V}$

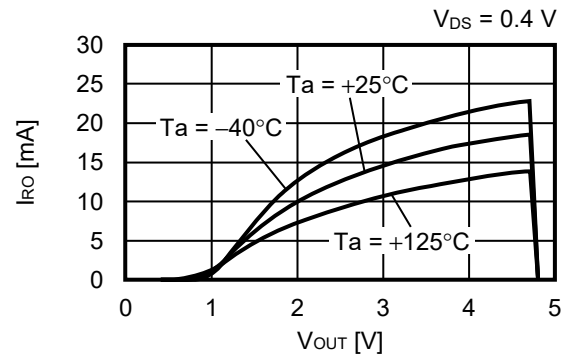

2.5 RO pin voltage vs. Output voltage

2.5.1 $-V_{DET} = 2.6\text{ V}$

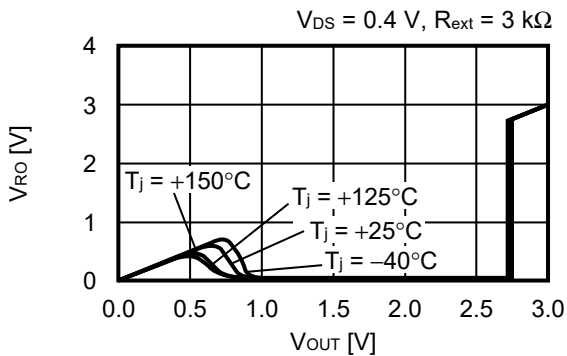

2.5.2 $-V_{DET} = 4.7\text{ V}$

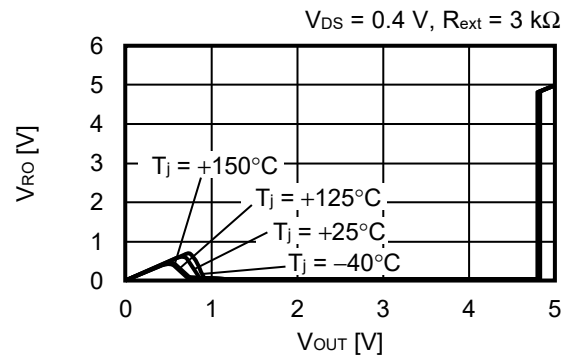

Remark I_{RO} : Nch transistor output current
 V_{RO} : Nch transistor output voltage
 V_{DS} : Drain-to-source voltage of Nch transistor

2.6 Release delay time vs. Junction temperature

2.6.1 $-V_{DET} = 2.6\text{ V}$

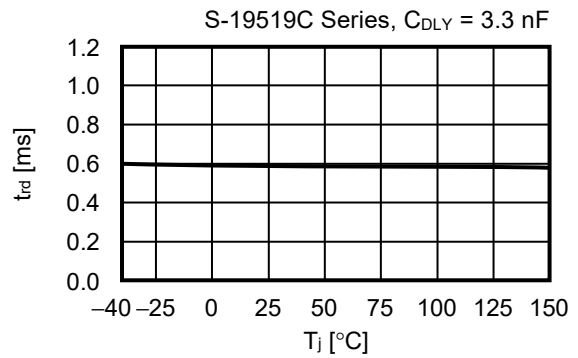
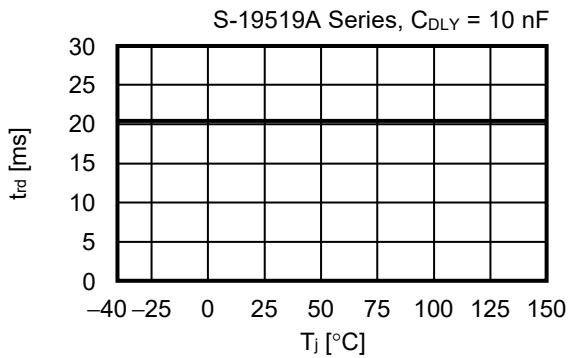

2.6.2 $-V_{DET} = 4.7\text{ V}$

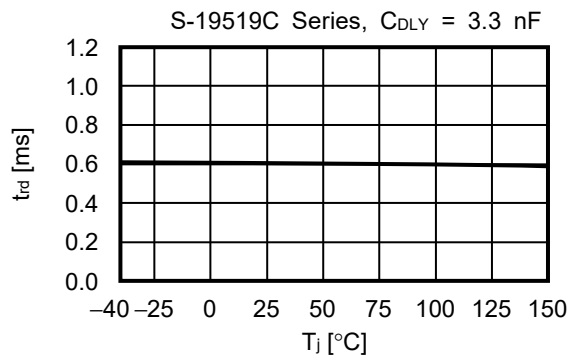
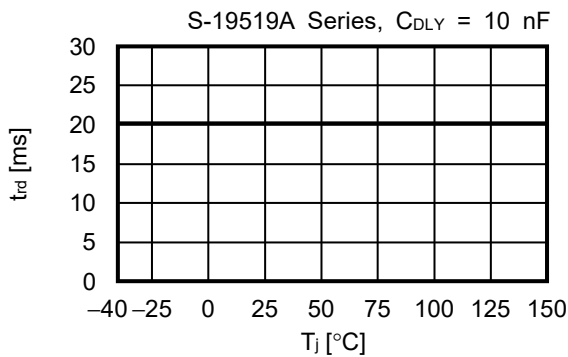

2.7 Release delay time vs. Release delay time and monitoring time adjustment capacitance

2.7.1 $-V_{DET} = 2.6\text{ V}$

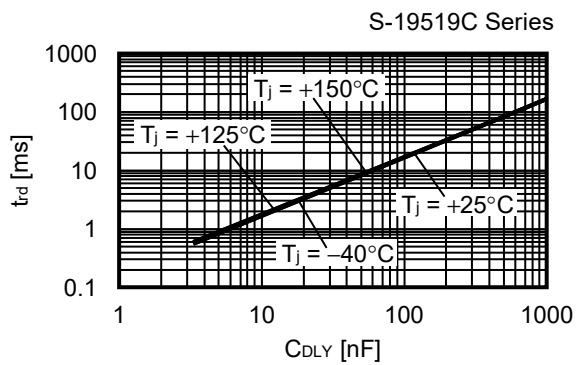
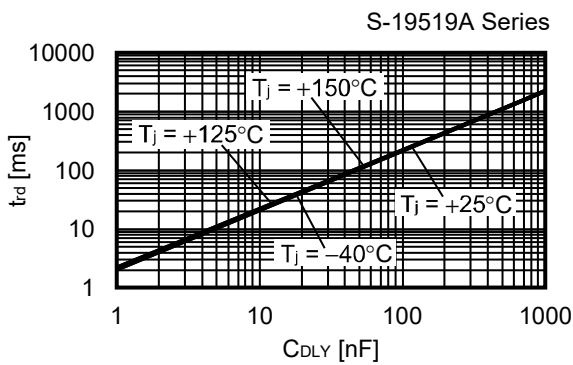

2.7.2 $-V_{DET} = 4.7\text{ V}$

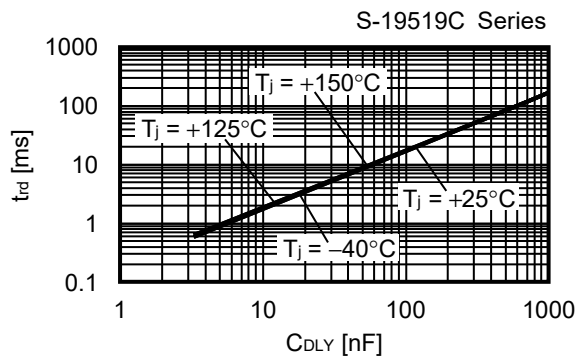
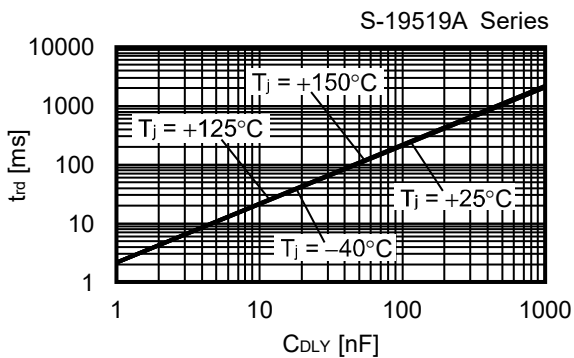

2. 8 Reset reaction time vs. Junction temperature

2. 8. 1 $-V_{DET} = 2.6 V$

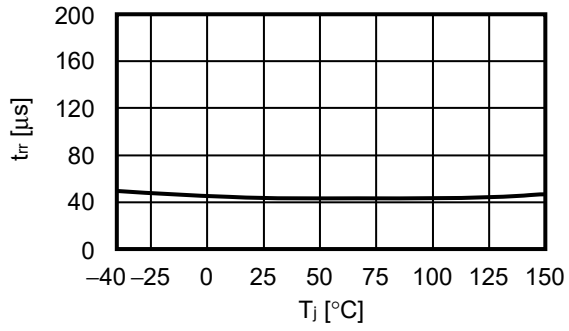

2. 8. 2 $-V_{DET} = 4.7 V$

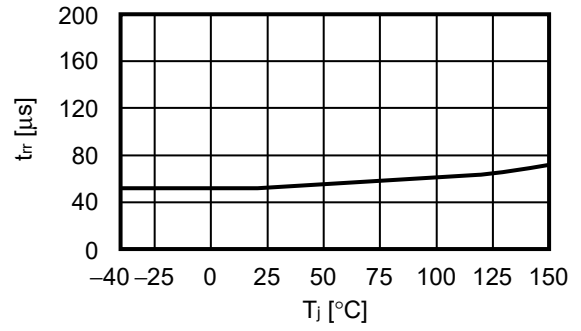

3. Watchdog timer block

3.1 Watchdog activation threshold current, watchdog deactivation threshold current vs. Junction temperature

3.1.1 $V_{OUT} = 3.3\text{ V}$

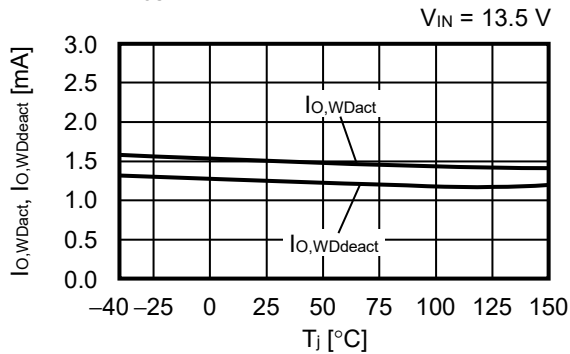

3.1.2 $V_{OUT} = 5.0\text{ V}$

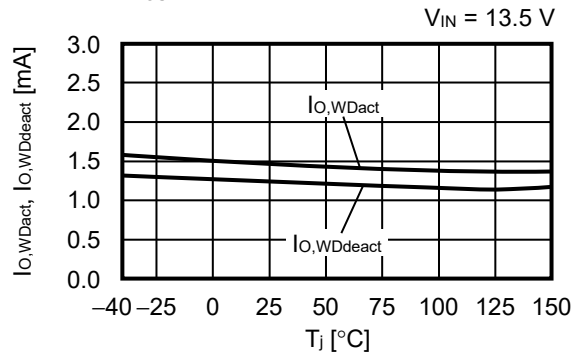

3.2 Watchdog activation threshold current, Watchdog deactivation threshold current vs. Watchdog activation threshold current adjustment resistance ($T_a = +25^\circ\text{C}$)

3.2.1 $V_{OUT} = 3.3\text{ V}$

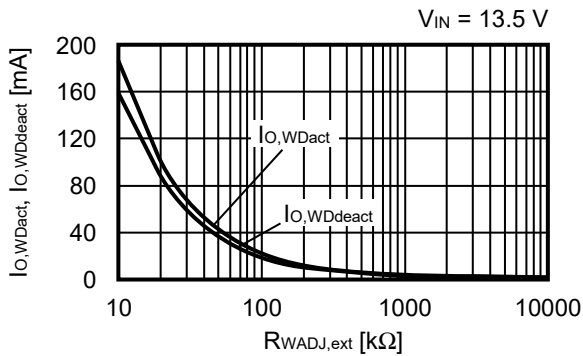

3.2.2 $V_{OUT} = 5.0\text{ V}$

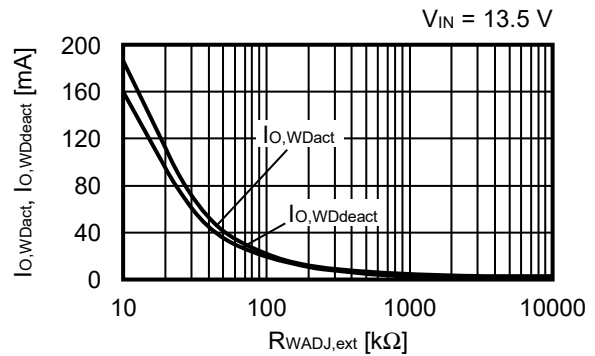

3.3 Watchdog trigger time vs. Junction temperature

3.3.1 $V_{OUT} = 3.3\text{ V}$

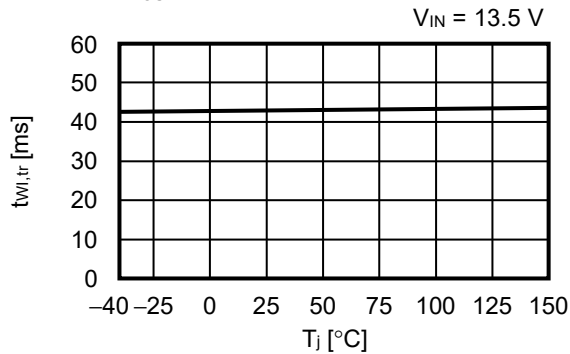

3.3.2 $V_{OUT} = 5.0\text{ V}$

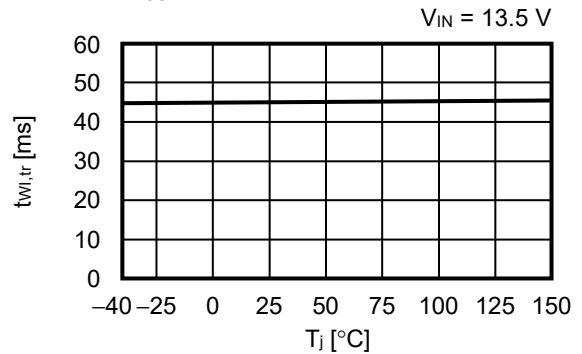

3.4 Watchdog trigger time vs. Release delay time and monitoring time adjustment capacitance

3.4.1 $V_{OUT} = 3.3\text{ V}$

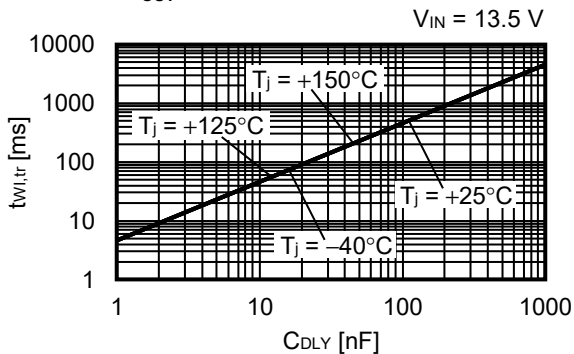

3.4.2 $V_{OUT} = 5.0\text{ V}$

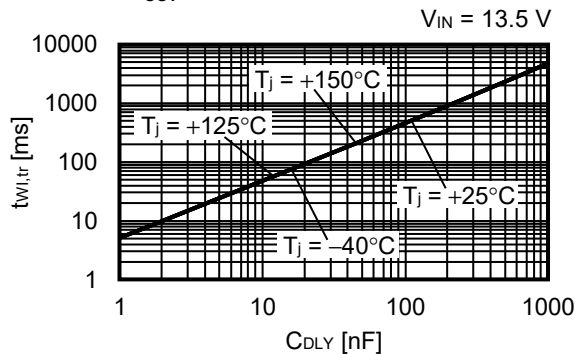

4. Overall

4.1 Current consumption during operation vs. Input voltage

4.1.1 $V_{OUT} = 3.3\text{ V}$, $-V_{DET} = 2.6\text{ V}$

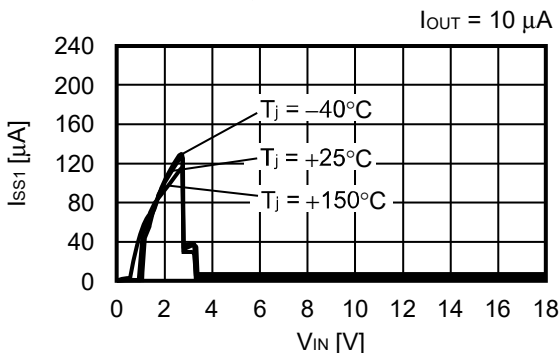

4.1.2 $V_{OUT} = 5.0\text{ V}$, $-V_{DET} = 4.7\text{ V}$

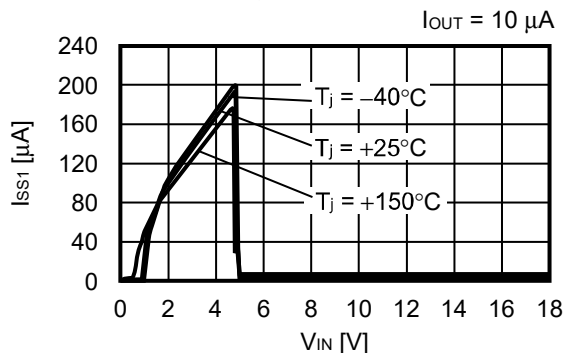

4.2 Current consumption during operation vs. Output current

4.2.1 $V_{OUT} = 3.3\text{ V}$, $-V_{DET} = 2.6\text{ V}$

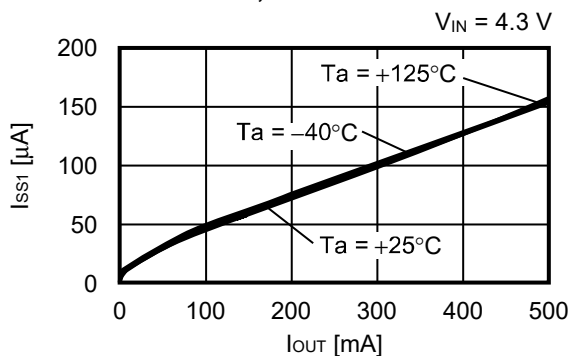

4.2.2 $V_{OUT} = 5.0\text{ V}$, $-V_{DET} = 4.7\text{ V}$

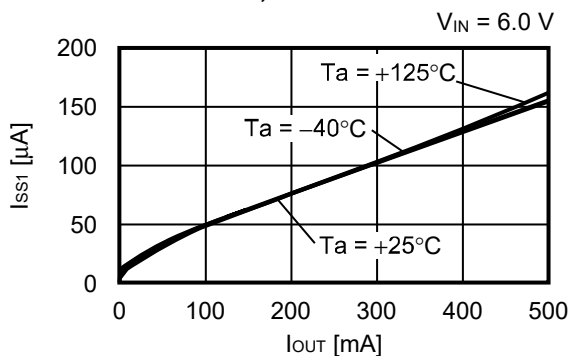

4.3 Current consumption during operation vs. Junction temperature

4.3.1 $V_{OUT} = 3.3\text{ V}$, $-V_{DET} = 2.6\text{ V}$

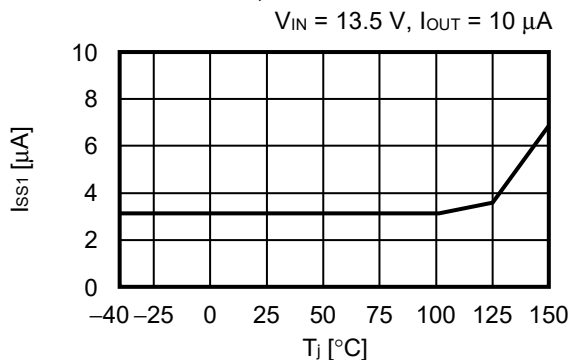

4.3.2 $V_{OUT} = 5.0\text{ V}$, $-V_{DET} = 4.7\text{ V}$

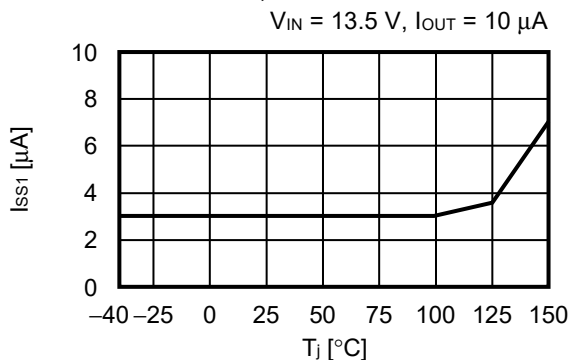

■ Reference Data

1. Characteristics of input transient response (Ta = +25°C)

1.1 V_{OUT} = 3.3 V

I_{OUT} = 0.1 mA, C_L = 1.0 μF, V_{IN} = 11.5 V ↔ 13.5 V, t_r = t_f = 5.0 μs

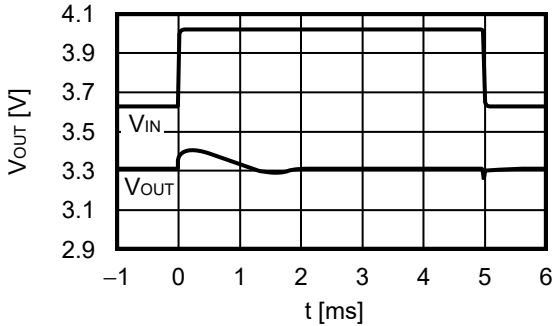

1.2 V_{OUT} = 5.0 V

I_{OUT} = 0.1 mA, C_L = 1.0 μF, V_{IN} = 11.5 V ↔ 13.5 V, t_r = t_f = 5.0 μs

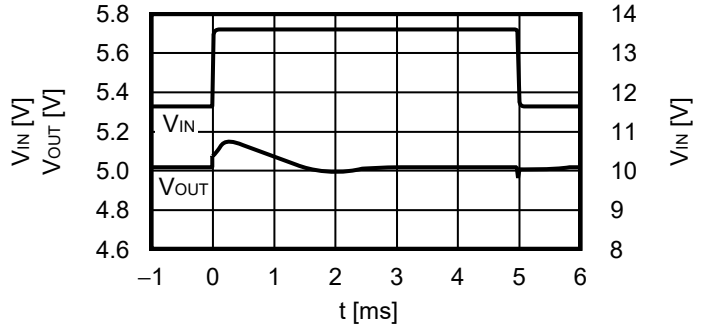

1.3 V_{OUT} = 3.3 V

I_{OUT} = 250 mA, C_L = 1.0 μF, V_{IN} = 11.5 V ↔ 13.5 V, t_r = t_f = 5.0 μs

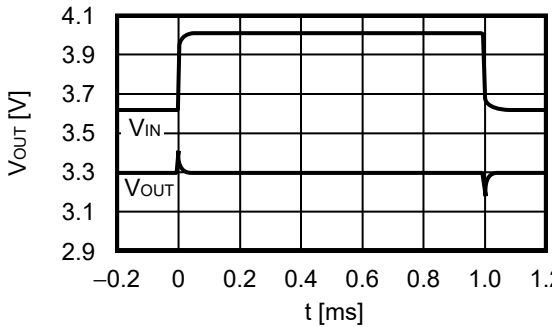

1.4 V_{OUT} = 5.0 V

I_{OUT} = 250 mA, C_L = 1.0 μF, V_{IN} = 11.5 V ↔ 13.5 V, t_r = t_f = 5.0 μs

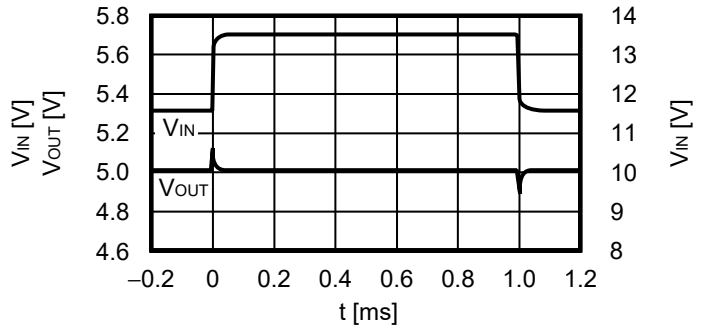

2. Characteristics of load transient response (Ta = +25°C)

2.1 V_{OUT} = 3.3 V

V_{IN} = 4.3 V, C_L = 1.0 μF, I_{OUT} = 50 mA ↔ 100 mA, t_r = t_f = 1.0 μs

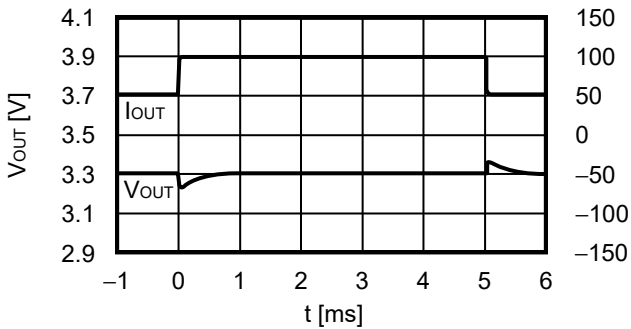

2.2 V_{OUT} = 5.0 V

V_{IN} = 6.0 V, C_L = 1.0 μF, I_{OUT} = 50 mA ↔ 100 mA, t_r = t_f = 1.0 μs

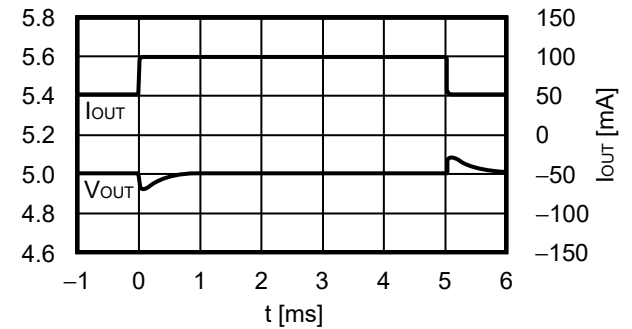

2.3 V_{OUT} = 3.3 V

V_{IN} = 4.3 V, C_L = 1.0 μF, I_{OUT} = 1 mA ↔ 250 mA, t_r = t_f = 1.0 μs

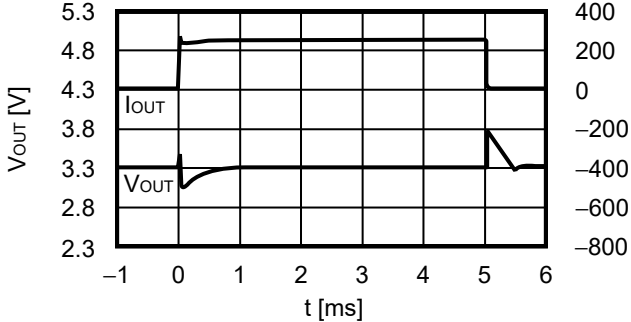

2.4 V_{OUT} = 5.0 V

V_{IN} = 6.0 V, C_L = 1.0 μF, I_{OUT} = 1 mA ↔ 250 mA, t_r = t_f = 1.0 μs

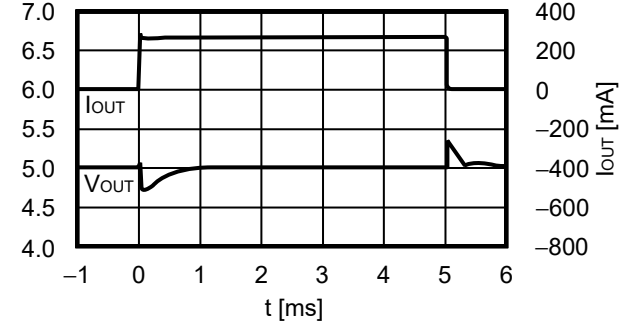

3. Load transient response characteristics dependent on capacitance (Ta = +25°C)

3.1 V_{OUT} = 3.3 V

3.1.1 I_{OUT} = 1.0 mA → 500 mA

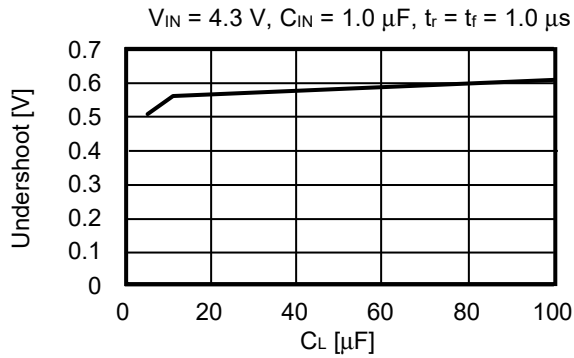

3.1.2 I_{OUT} = 500 mA → 1.0 mA

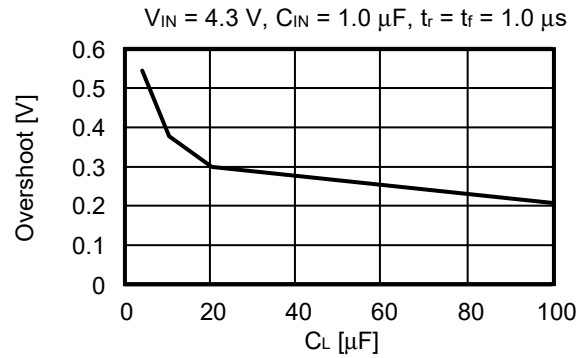

3.2 V_{OUT} = 5.0 V

3.2.1 I_{OUT} = 1.0 mA → 500 mA

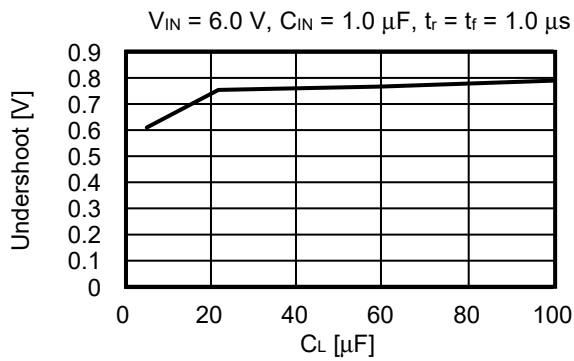

3.2.2 I_{OUT} = 500 mA → 1.0 mA

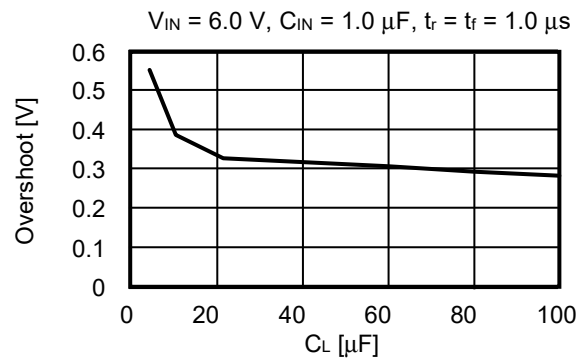

4. Characteristics of EN pin transient response (Ta = +25°C)

4.1 V_{OUT} = 3.3 V

V_{IN} = 13.5 V, C_L = 1.0 μF, I_{OUT} = 100 mA, V_{EN} = 0 V ↔ 13.5 V

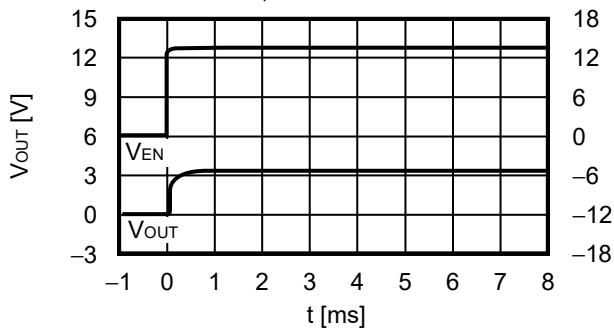

4.2 V_{OUT} = 5.0 V

V_{IN} = 13.5 V, C_L = 1.0 μF, I_{OUT} = 100 mA, V_{EN} = 0 V ↔ 13.5 V

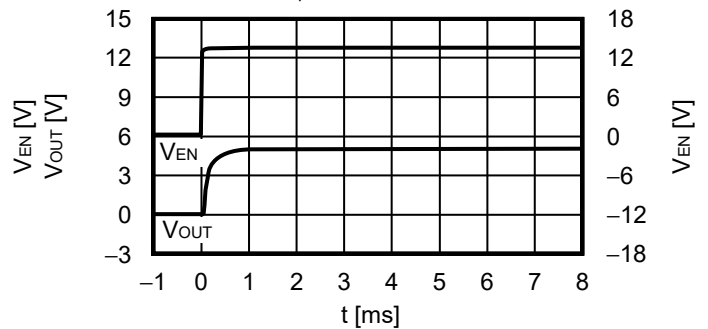

5. Load dump characteristics (Ta = +25°C)

5.1 V_{OUT} = 5.0 V

I_{OUT} = 0.1 mA, V_{IN} = 14.0 V ↔ 45.0 V, C_{IN} = C_L = 1.0 μF

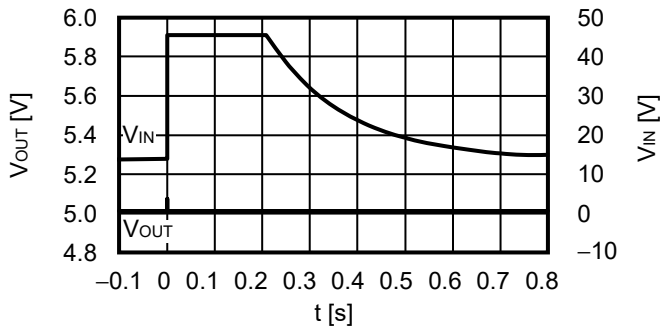

6. Example of equivalent series resistance vs. Output current characteristics (Ta = -40°C to +125°C)

C_{IN} = C_L = 1.0 μF, C_{DLY} = 10 nF

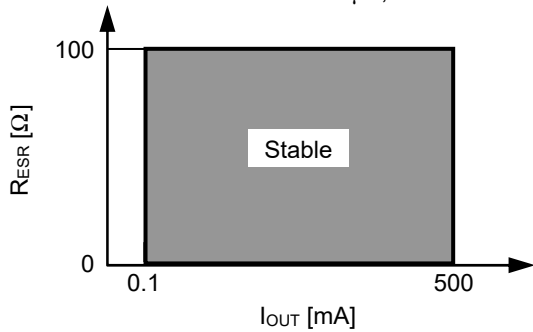
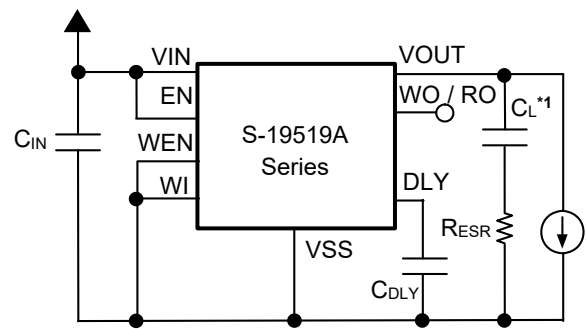

Figure 54



*1. C_L: TDK Corporation CGA5L3X8R1H105K (1.0 μF)

Figure 55

Power Dissipation

TO-252-9S

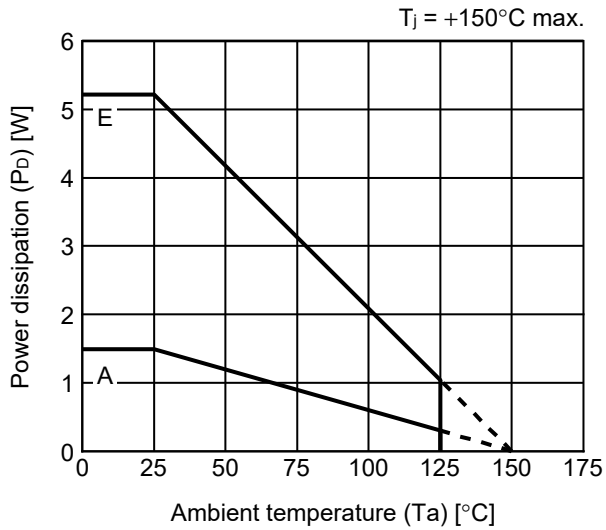

Board	Power Dissipation (P_D) ^{*1}
A	1.49 W
B	–
C	–
D	–
E	5.21 W

HSOP-8A

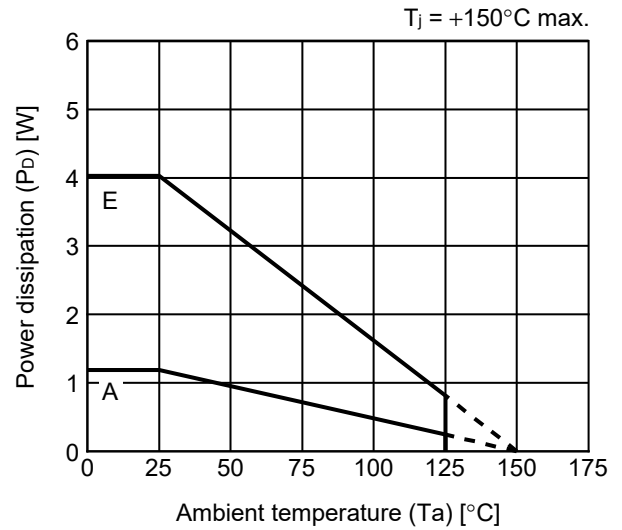

Board	Power Dissipation (P_D) ^{*1}
A	1.19 W
B	–
C	–
D	–
E	4.03 W

HTSSOP-16

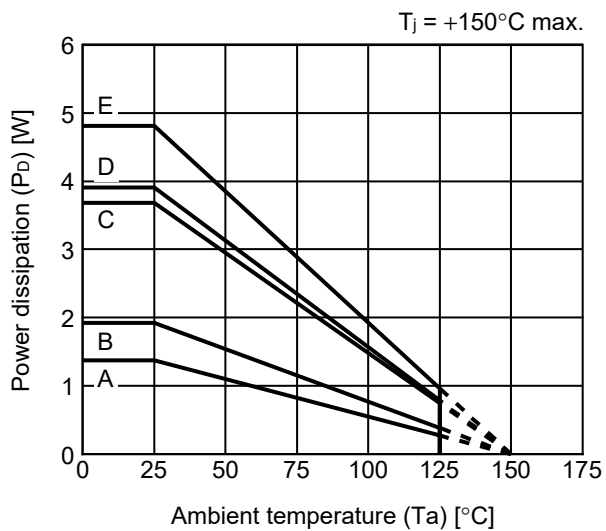

Board	Power Dissipation (P_D) ^{*1}
A	1.37 W
B	1.92 W
C	3.68 W
D	3.91 W
E	4.81 W

*1. Measurement values when this IC is mounted on each board

TO-252-9S Test Board

(1) Board A

 IC Mount Area

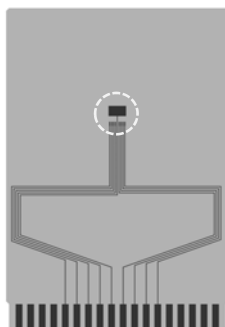

Item		Specification
Size [mm]		114.3 x 76.2 x t1.6
Material		FR-4
Number of copper foil layer		2
Copper foil layer [mm]	1	Land pattern and wiring for testing: t0.070
	2	-
	3	-
	4	74.2 x 74.2 x t0.070
Thermal via		-

(2) Board B

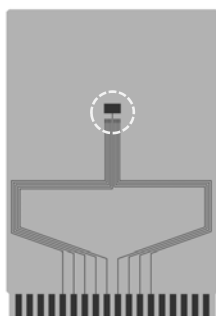

Item		Specification
Size [mm]		114.3 x 76.2 x t1.6
Material		FR-4
Number of copper foil layer		4
Copper foil layer [mm]	1	Land pattern and wiring for testing: t0.070
	2	74.2 x 74.2 x t0.035
	3	74.2 x 74.2 x t0.035
	4	74.2 x 74.2 x t0.070
Thermal via		-

(3) Board C

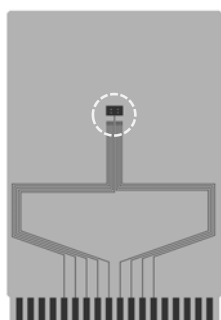

Item		Specification
Size [mm]		114.3 x 76.2 x t1.6
Material		FR-4
Number of copper foil layer		4
Copper foil layer [mm]	1	Land pattern and wiring for testing: t0.070
	2	74.2 x 74.2 x t0.035
	3	74.2 x 74.2 x t0.035
	4	74.2 x 74.2 x t0.070
Thermal via		Number: 4 Diameter: 0.3 mm



enlarged view

No. TO252-9S-A-Board-SD-1.0

TO-252-9S Test Board

(4) Board D

 IC Mount Area

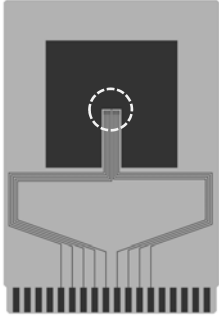

Item		Specification
Size [mm]		114.3 x 76.2 x t1.6
Material		FR-4
Number of copper foil layer		4
Copper foil layer [mm]	1	Pattern for heat radiation: 2000mm ² t0.070
	2	74.2 x 74.2 x t0.035
	3	74.2 x 74.2 x t0.035
	4	74.2 x 74.2 x t0.070
Thermal via		-

(5) Board E

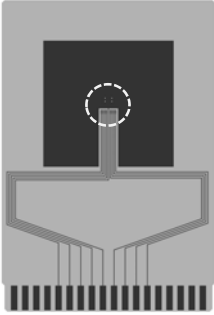

Item		Specification
Size [mm]		114.3 x 76.2 x t1.6
Material		FR-4
Number of copper foil layer		4
Copper foil layer [mm]	1	Pattern for heat radiation: 2000mm ² t0.070
	2	74.2 x 74.2 x t0.035
	3	74.2 x 74.2 x t0.035
	4	74.2 x 74.2 x t0.070
Thermal via		Number: 4 Diameter: 0.3 mm



enlarged view

No. TO252-9S-A-Board-SD-1.0

HSOP-8A Test Board

(1) Board A

 IC Mount Area

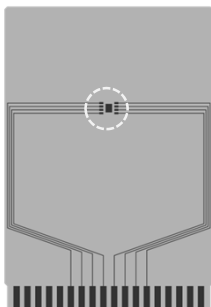

Item	Specification	
Size [mm]	114.3 x 76.2 x t1.6	
Material	FR-4	
Number of copper foil layer	2	
Copper foil layer [mm]	1	Land pattern and wiring for testing: t0.070
	2	-
	3	-
	4	74.2 x 74.2 x t0.070
Thermal via	-	

(2) Board B

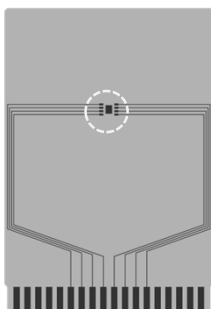

Item	Specification	
Size [mm]	114.3 x 76.2 x t1.6	
Material	FR-4	
Number of copper foil layer	4	
Copper foil layer [mm]	1	Land pattern and wiring for testing: t0.070
	2	74.2 x 74.2 x t0.035
	3	74.2 x 74.2 x t0.035
	4	74.2 x 74.2 x t0.070
Thermal via	-	

(3) Board C

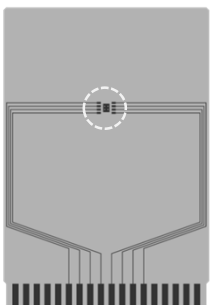

Item	Specification	
Size [mm]	114.3 x 76.2 x t1.6	
Material	FR-4	
Number of copper foil layer	4	
Copper foil layer [mm]	1	Land pattern and wiring for testing: t0.070
	2	74.2 x 74.2 x t0.035
	3	74.2 x 74.2 x t0.035
	4	74.2 x 74.2 x t0.070
Thermal via	Number: 4 Diameter: 0.3 mm	

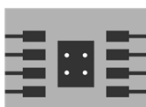

enlarged view

No. HSOP8A-A-Board-SD-1.0

HSOP-8A Test Board

(4) Board D

 IC Mount Area

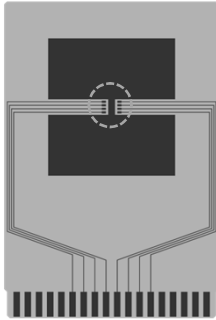

Item	Specification	
Size [mm]	114.3 x 76.2 x t1.6	
Material	FR-4	
Number of copper foil layer	4	
Copper foil layer [mm]	1	Pattern for heat radiation: 2000mm ² t0.070
	2	74.2 x 74.2 x t0.035
	3	74.2 x 74.2 x t0.035
	4	74.2 x 74.2 x t0.070
Thermal via	-	

(5) Board E

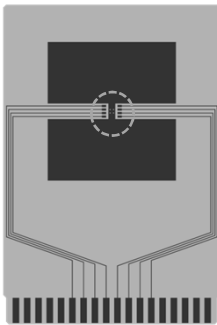

Item	Specification	
Size [mm]	114.3 x 76.2 x t1.6	
Material	FR-4	
Number of copper foil layer	4	
Copper foil layer [mm]	1	Pattern for heat radiation: 2000mm ² t0.070
	2	74.2 x 74.2 x t0.035
	3	74.2 x 74.2 x t0.035
	4	74.2 x 74.2 x t0.070
Thermal via	Number: 4 Diameter: 0.3 mm	



enlarged view

No. HSOP8A-A-Board-SD-1.0

HTSSOP-16 Test Board

 IC Mount Area

(1) Board A

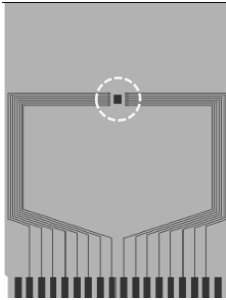

Item	Specification	
Size [mm]	114.3 x 76.2 x t1.6	
Material	FR-4	
Number of copper foil layer	2	
Copper foil layer [mm]	1	Land pattern and wiring for testing: t0.070
	2	-
	3	-
	4	74.2 x 74.2 x t0.070
Thermal via	-	

(2) Board B

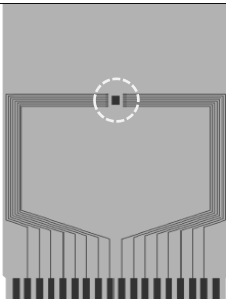

Item	Specification	
Size [mm]	114.3 x 76.2 x t1.6	
Material	FR-4	
Number of copper foil layer	4	
Copper foil layer [mm]	1	Land pattern and wiring for testing: t0.070
	2	74.2 x 74.2 x t0.035
	3	74.2 x 74.2 x t0.035
	4	74.2 x 74.2 x t0.070
Thermal via	-	

(3) Board C

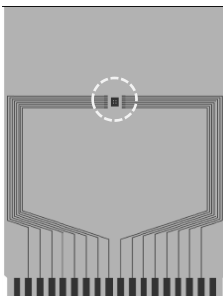

Item	Specification	
Size [mm]	114.3 x 76.2 x t1.6	
Material	FR-4	
Number of copper foil layer	4	
Copper foil layer [mm]	1	Land pattern and wiring for testing: t0.070
	2	74.2 x 74.2 x t0.035
	3	74.2 x 74.2 x t0.035
	4	74.2 x 74.2 x t0.070
Thermal via	Number: 4 Diameter: 0.3 mm	



enlarged view

No. HTSSOP16-A-Board-SD-1.0

HTSSOP-16 Test Board

 IC Mount Area

(4) Board D

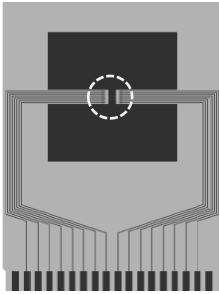

Item	Specification	
Size [mm]	114.3 x 76.2 x t1.6	
Material	FR-4	
Number of copper foil layer	4	
Copper foil layer [mm]	1	Pattern for heat radiation: 2000mm ² t0.070
	2	74.2 x 74.2 x t0.035
	3	74.2 x 74.2 x t0.035
	4	74.2 x 74.2 x t0.070
Thermal via	-	

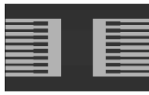

enlarged view

(5) Board E

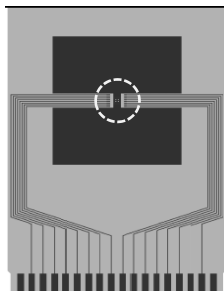

Item	Specification	
Size [mm]	114.3 x 76.2 x t1.6	
Material	FR-4	
Number of copper foil layer	4	
Copper foil layer [mm]	1	Pattern for heat radiation: 2000mm ² t0.070
	2	74.2 x 74.2 x t0.035
	3	74.2 x 74.2 x t0.035
	4	74.2 x 74.2 x t0.070
Thermal via	Number: 4 Diameter: 0.3 mm	



enlarged view

No. HTSSOP16-A-Board-SD-1.0

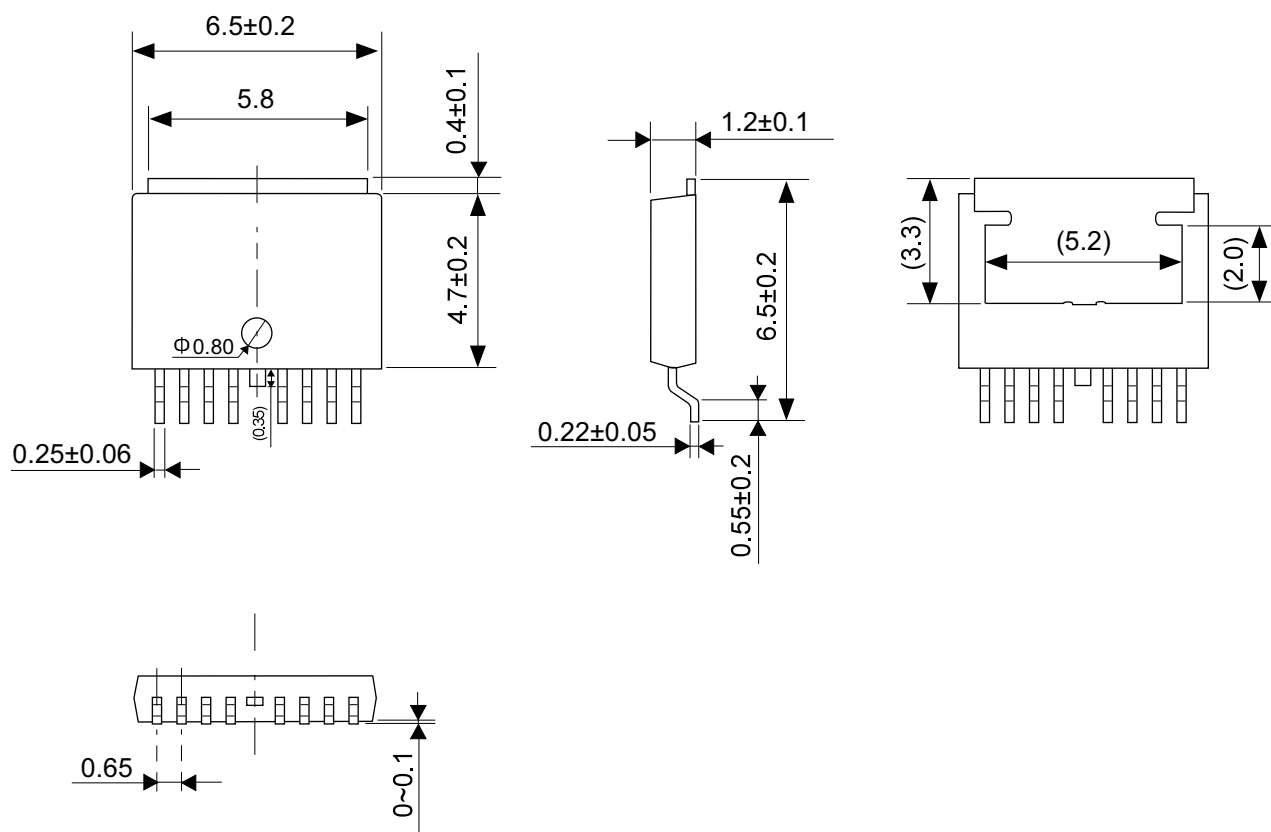

No. VA009-A-P-SD-2.0

TITLE	TO252-9S-A-PKG Dimensions
No.	VA009-A-P-SD-2.0
ANGLE	
UNIT	mm
ABLIC Inc.	

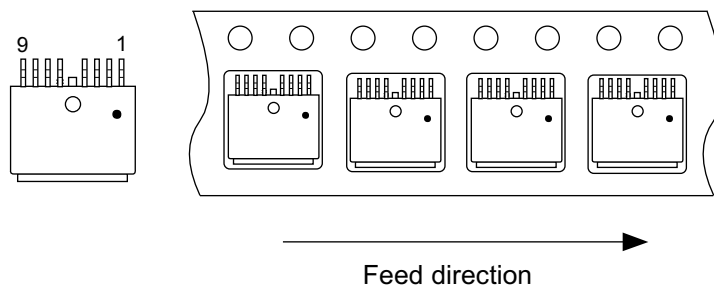
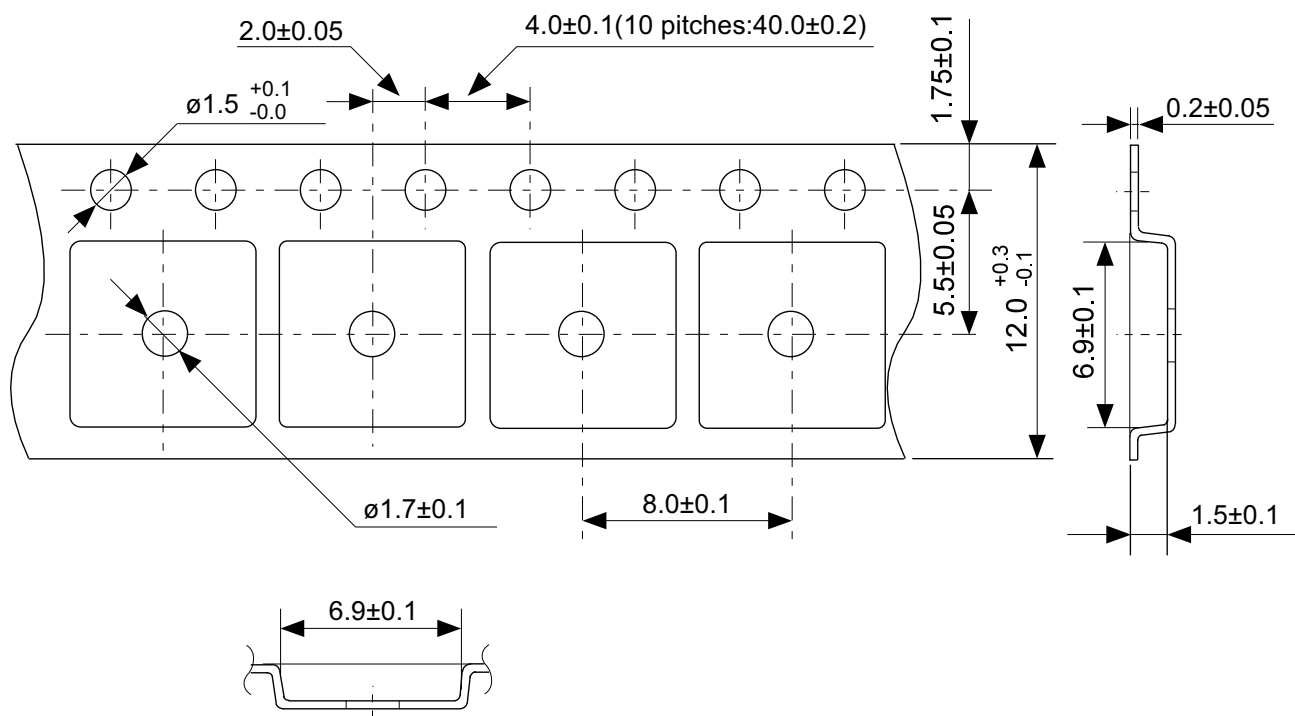

No. VA009-A-C-SD-1.0

TITLE	TO252-9S-A-Carrier Tape
No.	VA009-A-C-SD-1.0
ANGLE	
UNIT	mm
ABLIC Inc.	

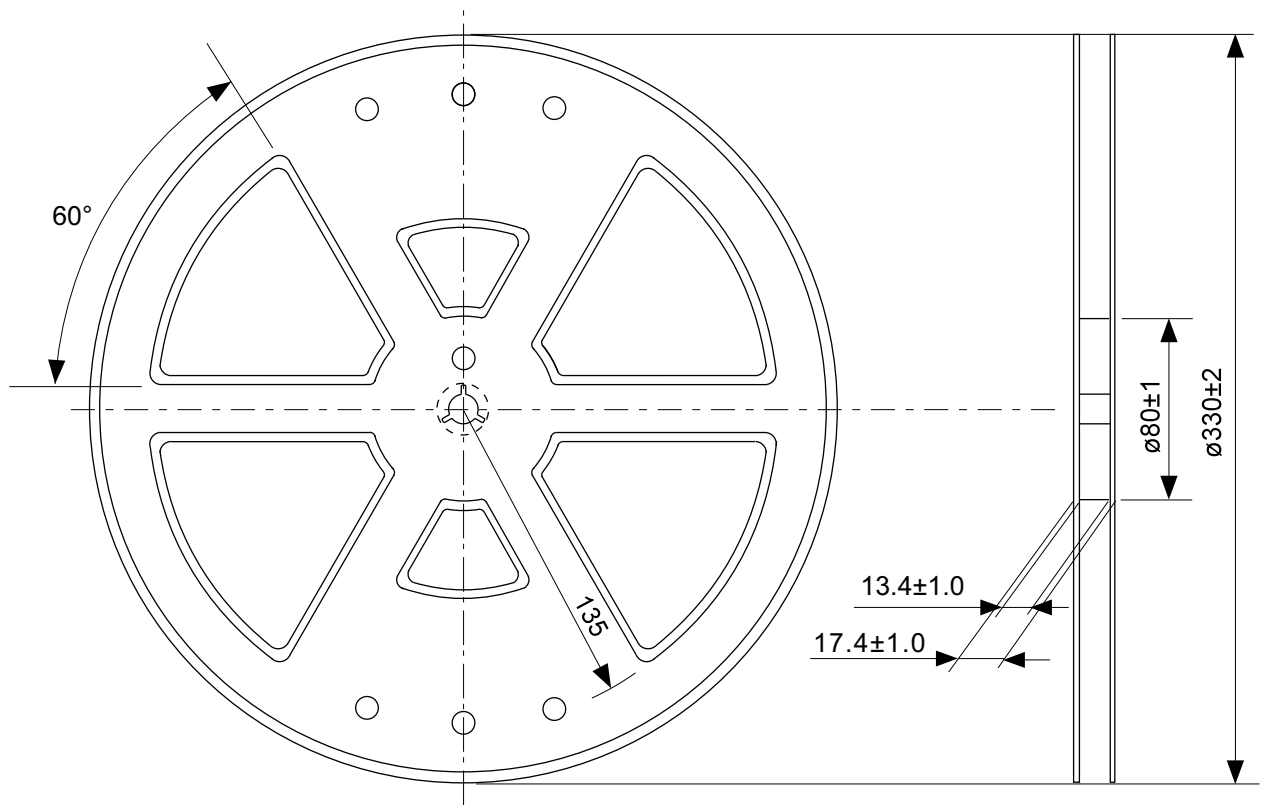

Enlarged drawing in the central part

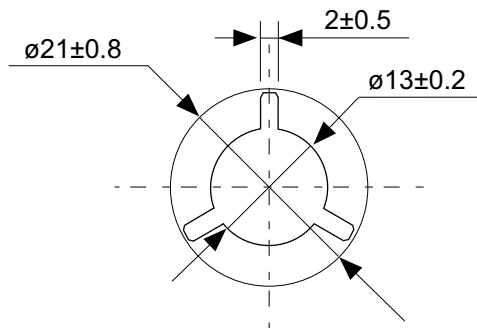

No. VA009-A-R-SD-1.1

TITLE	TO252-9S-A-Reel		
No.	VA009-A-R-SD-1.1		
ANGLE		QTY.	4,000
UNIT	mm		
ABLIC Inc.			

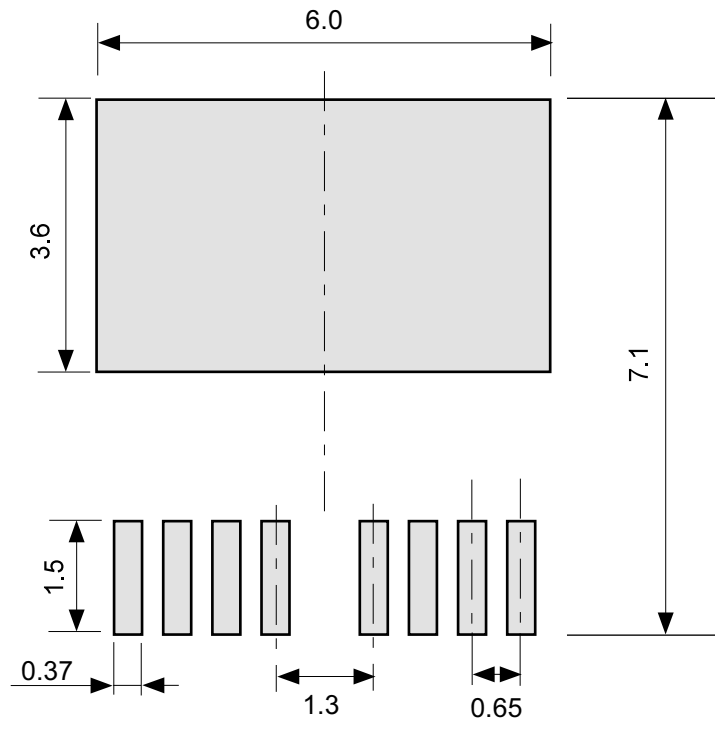

No. VA009-A-L-SD-1.0

TITLE	TO252-9S-A -Land Recommendation
No.	VA009-A-L-SD-1.0
ANGLE	
UNIT	mm
ABLIC Inc.	

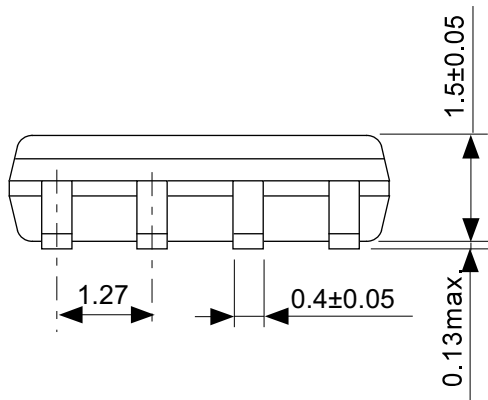
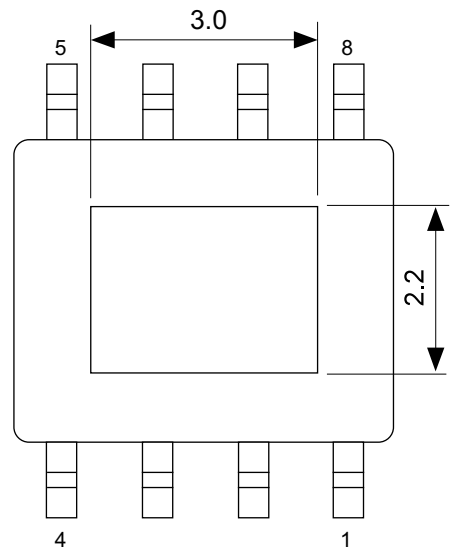
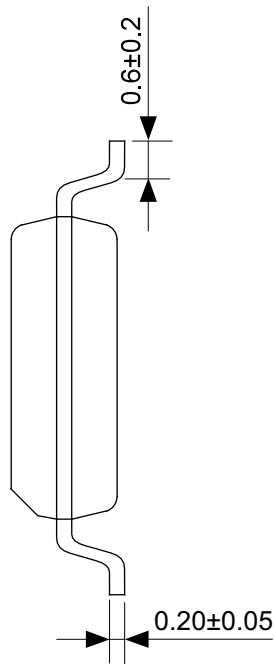
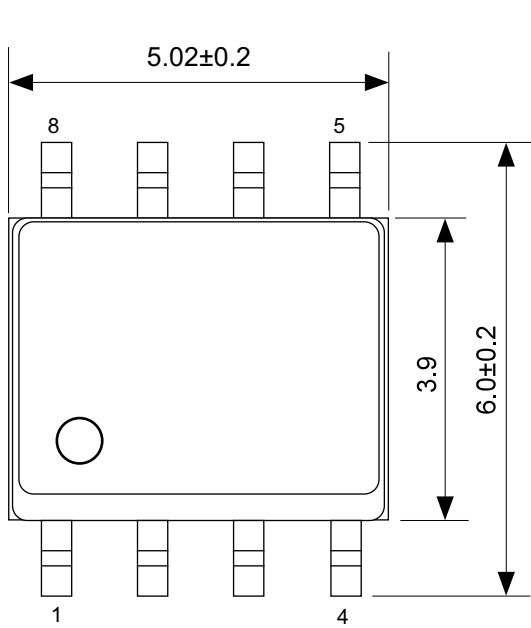

No. FH008-A-P-SD-2.0

TITLE	HSOP8A-A-PKG Dimensions
No.	FH008-A-P-SD-2.0
ANGLE	
UNIT	mm
ABLIC Inc.	

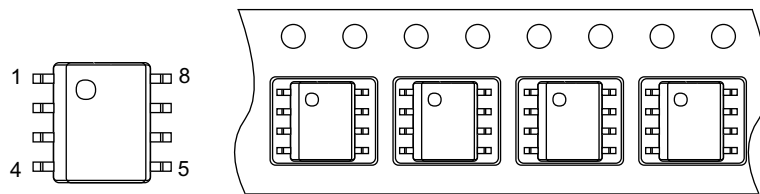
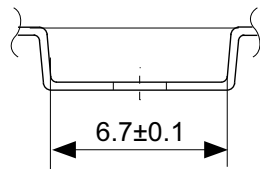
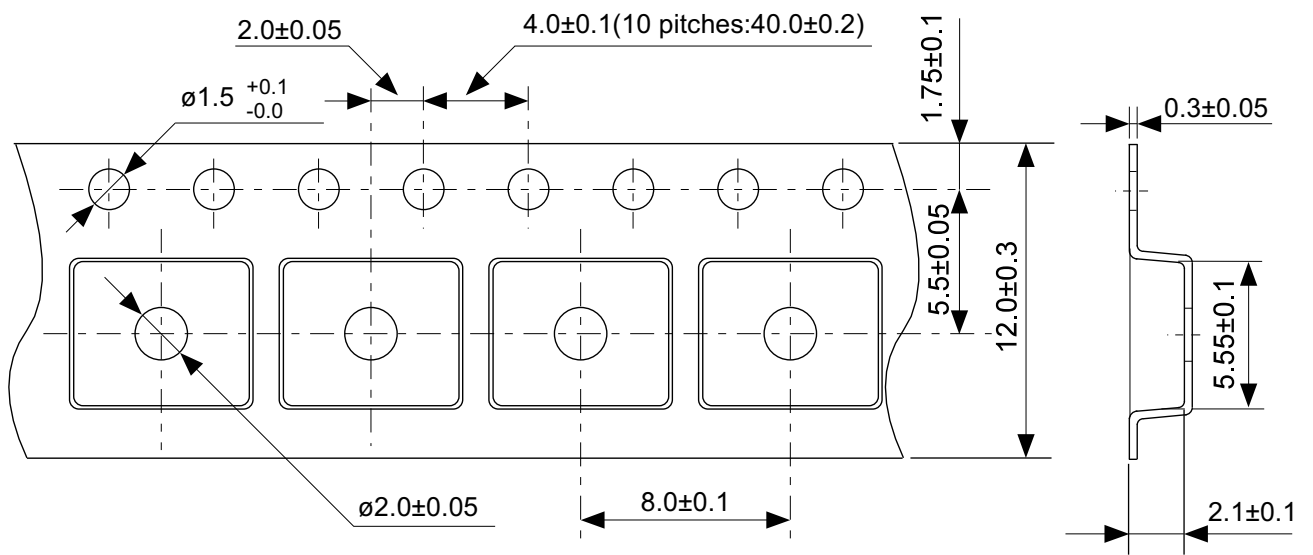

→
Feed direction

No. FH008-A-C-SD-1.0

TITLE	HSOP8A-A-Carrier Tape
No.	FH008-A-C-SD-1.0
ANGLE	
UNIT	mm
ABLIC Inc.	

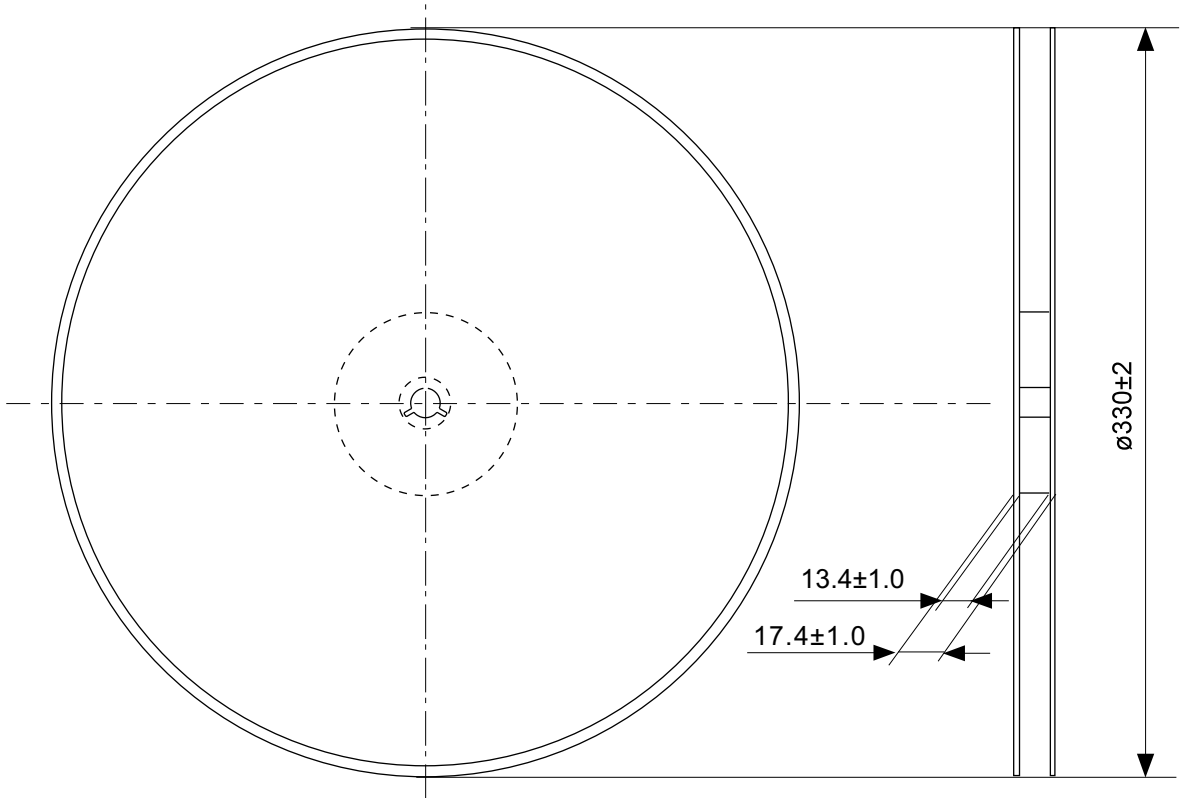

Enlarged drawing in the central part

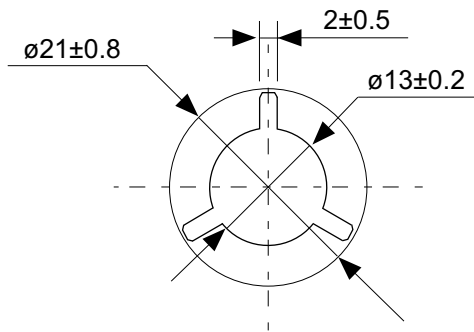

No. FH008-A-R-SD-1.1

TITLE	HSOP8A-A-Reel		
No.	FH008-A-R-SD-1.1		
ANGLE		QTY.	4,000
UNIT	mm		
ABLIC Inc.			

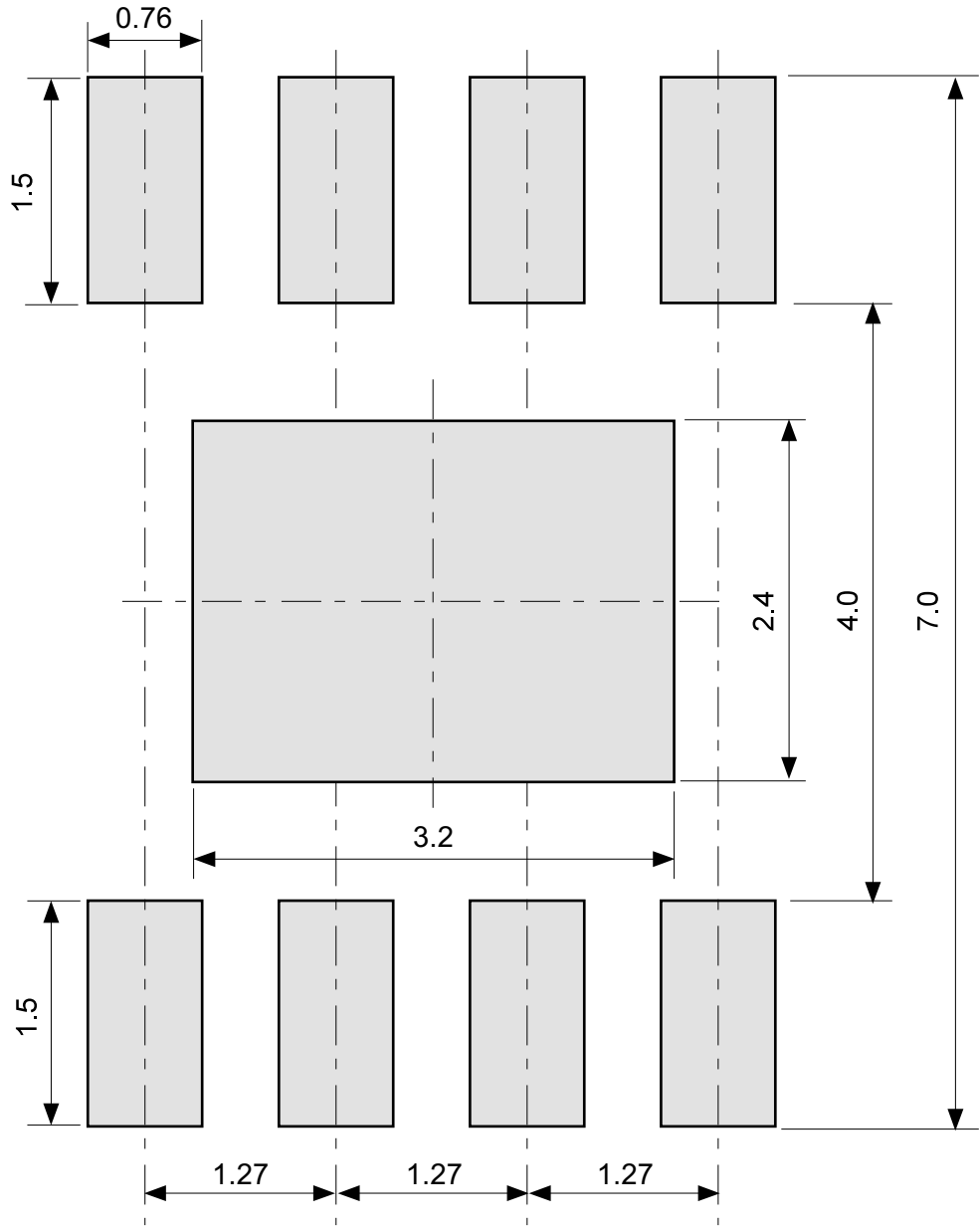

No. FH008-A-L-SD-1.0

TITLE	HSOP8A-A -Land Recommendation
No.	FH008-A-L-SD-1.0
ANGLE	
UNIT	mm
ABLIC Inc.	

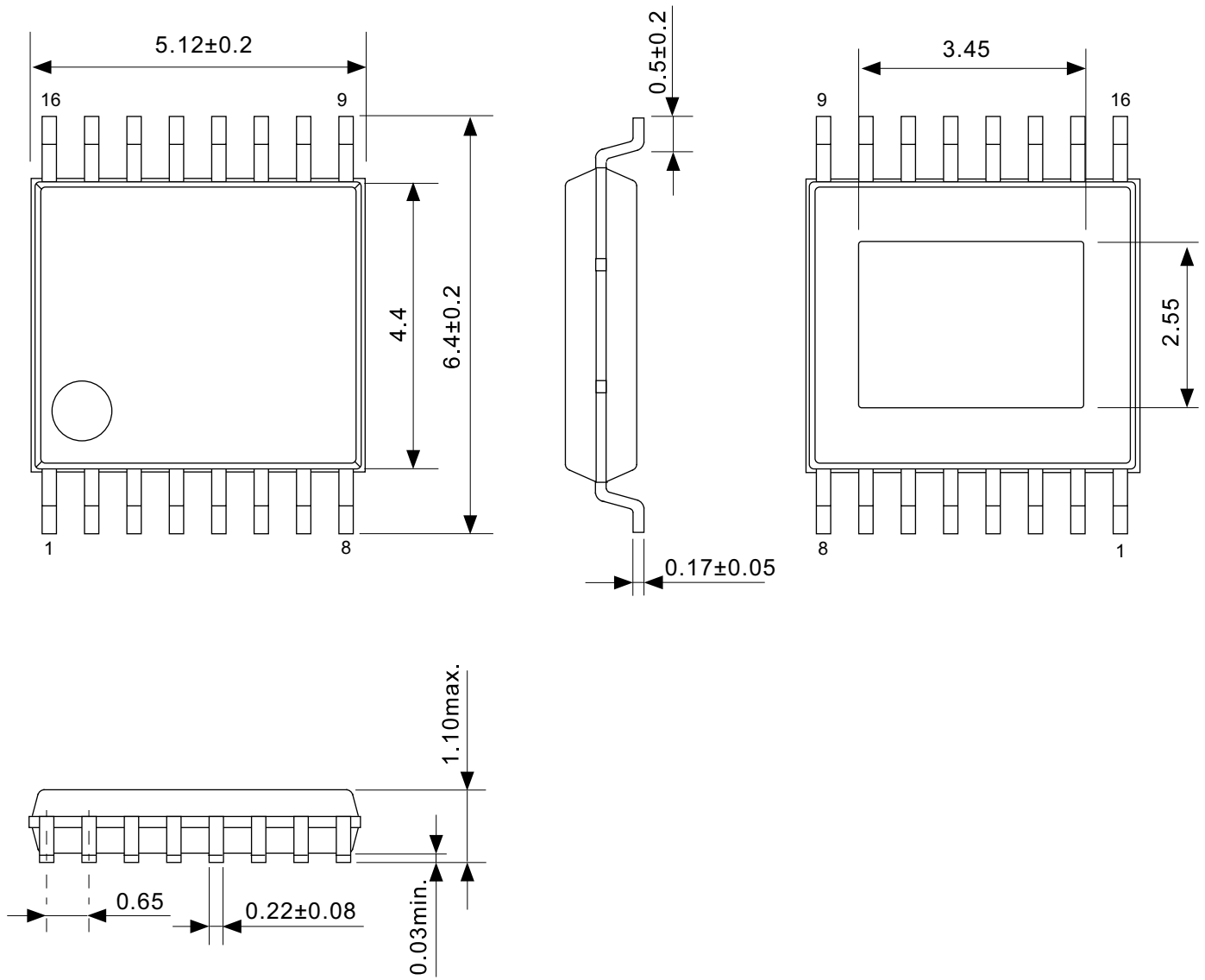

No. FR016-A-P-SD-1.0

TITLE	HTSSOP16-A-PKG Dimensions
No.	FR016-A-P-SD-1.0
ANGLE	
UNIT	mm
ABLIC Inc.	

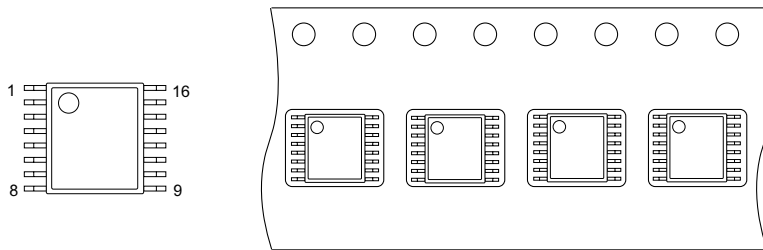
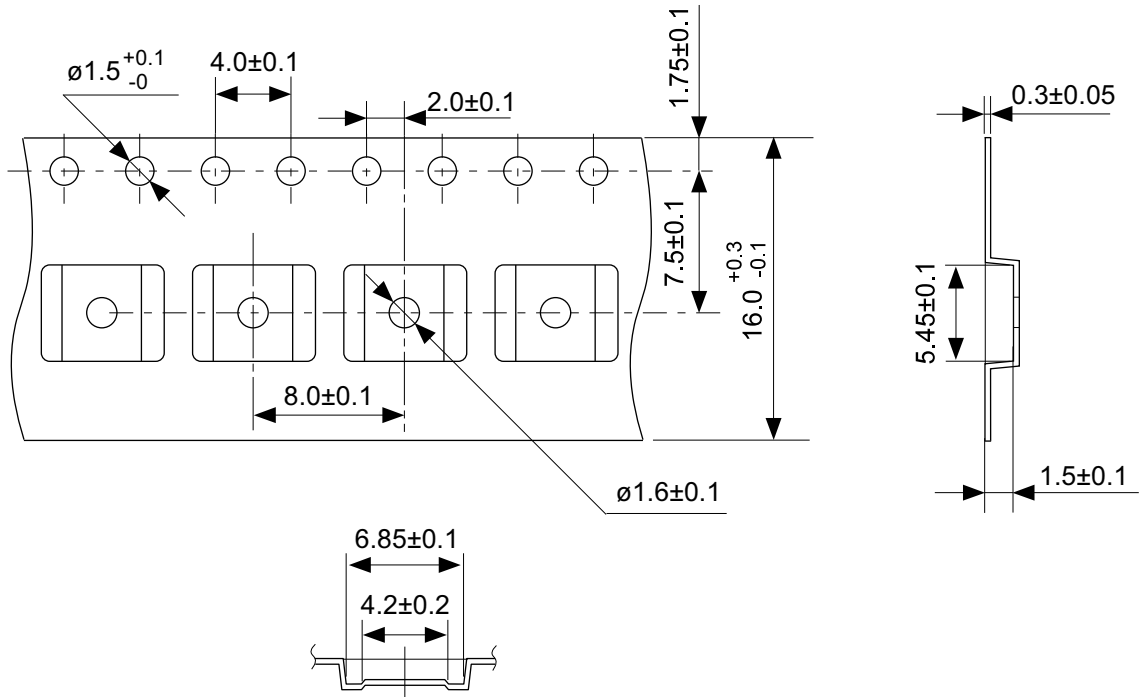

Feed direction

No. FR016-A-C-SD-1.0

TITLE	HTSSOP16-A-Carrier Tape
No.	FR016-A-C-SD-1.0
ANGLE	
UNIT	mm
ABLIC Inc.	

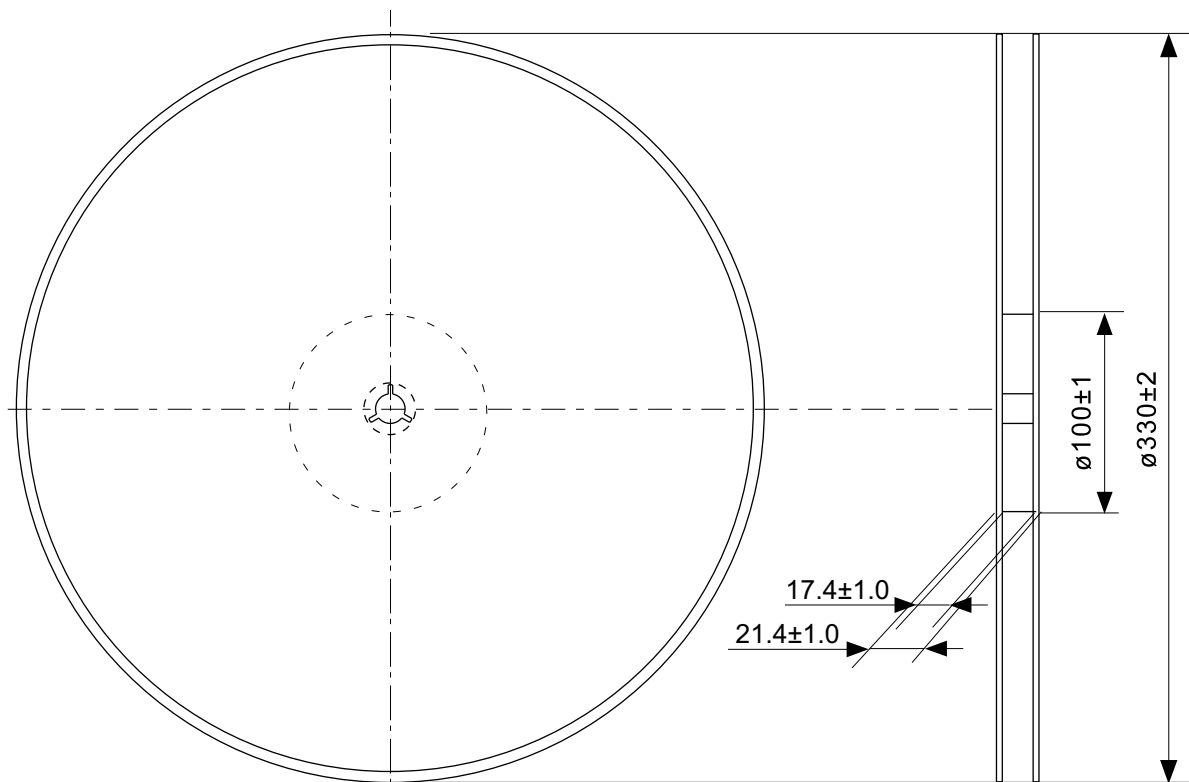

Enlarged drawing in the central part

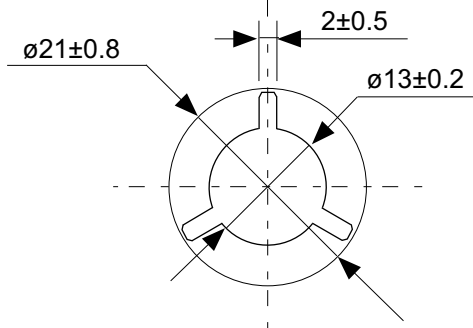

No. FR016-A-R-SD-1.0

TITLE	HTSSOP16-A- Reel		
No.	FR016-A-R-SD-1.0		
ANGLE		QTY.	4,000
UNIT	mm		
ABLIC Inc.			

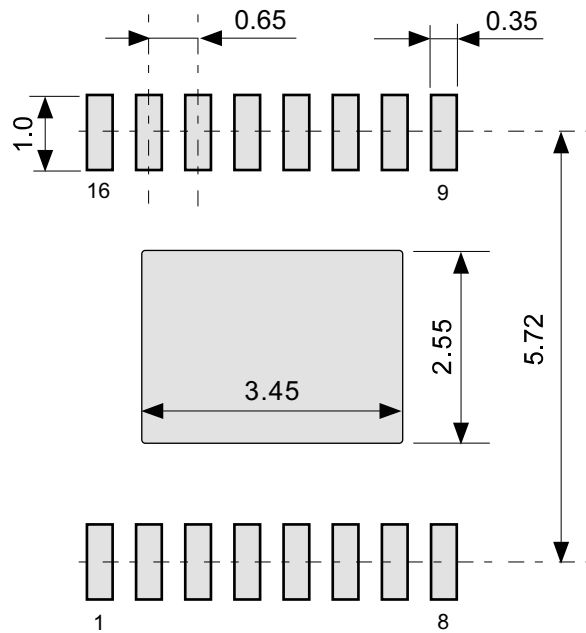

No. FR016-A-L-SD-1.0

TITLE	HTSSOP16-A -Land Recommendation
No.	FR016-A-L-SD-1.0
ANGLE	
UNIT	mm
ABLIC Inc.	

Disclaimers (Handling Precautions)

1. All the information described herein (product data, specifications, figures, tables, programs, algorithms and application circuit examples, etc.) is current as of publishing date of this document and is subject to change without notice.
2. The circuit examples and the usages described herein are for reference only, and do not guarantee the success of any specific mass-production design.
ABLIC Inc. is not liable for any losses, damages, claims or demands caused by the reasons other than the products described herein (hereinafter "the products") or infringement of third-party intellectual property right and any other right due to the use of the information described herein.
3. ABLIC Inc. is not liable for any losses, damages, claims or demands caused by the incorrect information described herein.
4. Be careful to use the products within their ranges described herein. Pay special attention for use to the absolute maximum ratings, operation voltage range and electrical characteristics, etc.
ABLIC Inc. is not liable for any losses, damages, claims or demands caused by failures and / or accidents, etc. due to the use of the products outside their specified ranges.
5. Before using the products, confirm their applications, and the laws and regulations of the region or country where they are used and verify suitability, safety and other factors for the intended use.
6. When exporting the products, comply with the Foreign Exchange and Foreign Trade Act and all other export-related laws, and follow the required procedures.
7. The products are strictly prohibited from using, providing or exporting for the purposes of the development of weapons of mass destruction or military use. ABLIC Inc. is not liable for any losses, damages, claims or demands caused by any provision or export to the person or entity who intends to develop, manufacture, use or store nuclear, biological or chemical weapons or missiles, or use any other military purposes.
8. The products are not designed to be used as part of any device or equipment that may affect the human body, human life, or assets (such as medical equipment, disaster prevention systems, security systems, combustion control systems, infrastructure control systems, vehicle equipment, traffic systems, in-vehicle equipment, aviation equipment, aerospace equipment, and nuclear-related equipment), excluding when specified for in-vehicle use or other uses by ABLIC, Inc. Do not apply the products to the above listed devices and equipments.
ABLIC Inc. is not liable for any losses, damages, claims or demands caused by unauthorized or unspecified use of the products.
9. In general, semiconductor products may fail or malfunction with some probability. The user of the products should therefore take responsibility to give thorough consideration to safety design including redundancy, fire spread prevention measures, and malfunction prevention to prevent accidents causing injury or death, fires and social damage, etc. that may ensue from the products' failure or malfunction.
The entire system in which the products are used must be sufficiently evaluated and judged whether the products are allowed to apply for the system on customer's own responsibility.
10. The products are not designed to be radiation-proof. The necessary radiation measures should be taken in the product design by the customer depending on the intended use.
11. The products do not affect human health under normal use. However, they contain chemical substances and heavy metals and should therefore not be put in the mouth. The fracture surfaces of wafers and chips may be sharp. Be careful when handling these with the bare hands to prevent injuries, etc.
12. When disposing of the products, comply with the laws and ordinances of the country or region where they are used.
13. The information described herein contains copyright information and know-how of ABLIC Inc. The information described herein does not convey any license under any intellectual property rights or any other rights belonging to ABLIC Inc. or a third party. Reproduction or copying of the information from this document or any part of this document described herein for the purpose of disclosing it to a third-party is strictly prohibited without the express permission of ABLIC Inc.
14. For more details on the information described herein or any other questions, please contact ABLIC Inc.'s sales representative.
15. This Disclaimers have been delivered in a text using the Japanese language, which text, despite any translations into the English language and the Chinese language, shall be controlling.

2.4-2019.07