

**HIGH-WITHSTAND VOLTAGE LOW CURRENT CONSUMPTION
LOW DROPOUT CMOS VOLTAGE REGULATOR**www.abilic.com

© ABLIC Inc., 2012-2013

Rev.1.1_02

The S-1142C/DxxA Series, developed by using high-withstand voltage CMOS technology, is a positive voltage regulator with a high-withstand voltage, low current consumption, and high-accuracy output voltage.

The S-1142C/DxxA Series operates at a high maximum operating voltage of 50 V and a low current consumption of 4.0 μ A typ. In addition to a built-in low on-resistance transistor which provides a very small dropout voltage and a large output current, this voltage regulator also has a built-in ON / OFF circuit.

An overcurrent protection circuit prevents the load current from exceeding the capacitance of the output transistor, and a built-in thermal shutdown circuit prevents damage caused by heat.

A high heat radiation HSOP-6 package enables high-density mounting.

Caution Before using the product in automobile control unit or medical equipment, contact to ABLIC Inc. is indispensable.

■ Features

- Output voltage: 2.0 V to 12.0 V, selectable in 0.1 V step
- Input voltage: 3.0 V to 50 V
- Output voltage accuracy: $\pm 1.0\%$ ($T_j = +25^\circ\text{C}$)
 $\pm 4.0\%$ ($T_j = -40^\circ\text{C}$ to $+125^\circ\text{C}$)
- Current consumption: During operation: 4.0 μ A typ., 15.0 μ A max. ($T_j = -40^\circ\text{C}$ to $+135^\circ\text{C}$)
During power-off: 0.1 μ A typ., 3.5 μ A max. ($T_j = -40^\circ\text{C}$ to $+135^\circ\text{C}$)
- Output current: Possible to output 200 mA ($V_{IN} \geq V_{OUT(S)} + 2.0 \text{ V}$)*1
- Input and output capacitors: A ceramic capacitor of 0.1 μ F or more can be used.
- Built-in overcurrent protection circuit: Limits overcurrent of output transistor.
- Built-in thermal shutdown circuit: Prevents damage caused by heat.
- Built-in ON / OFF circuit: Ensures long battery life.
- Operation temperature range: $T_a = -40^\circ\text{C}$ to $+125^\circ\text{C}$
- Lead-free (Sn 100%), halogen-free

*1. Attention should be paid to the power dissipation of the package when the output current is large.

■ Applications

- Constant-voltage power supply for application of vehicle interior electric equipment
- Constant-voltage power supply for home electric appliance

■ Package

- HSOP-6

■ Block Diagram

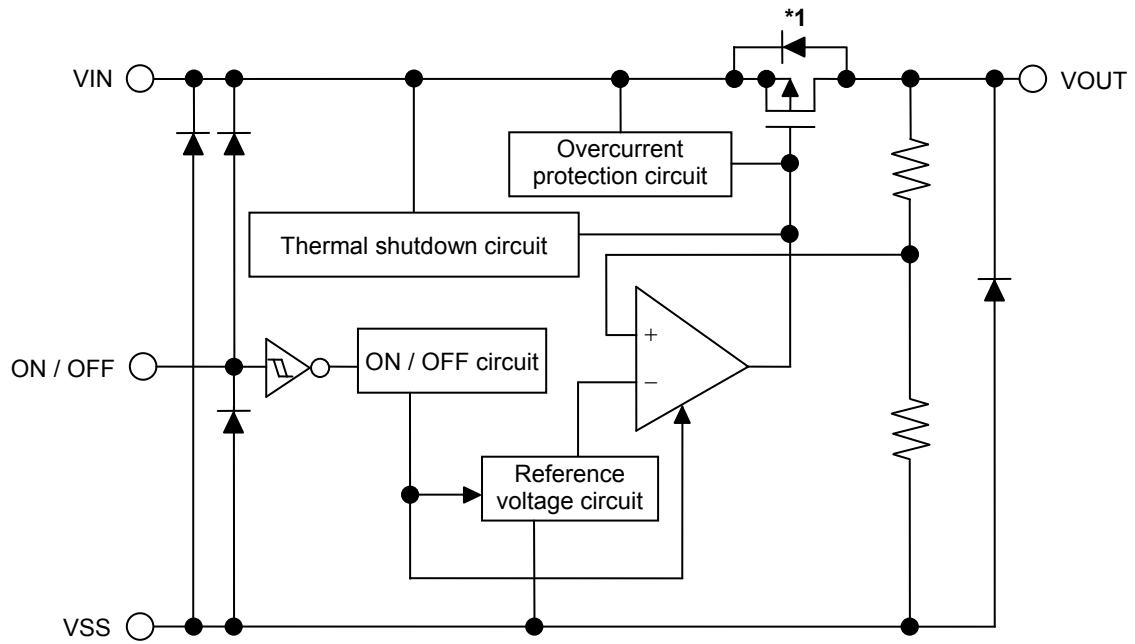

*1. Parasitic diode

Figure 1

■ Product Name Structure

Users can select the product type and output voltage for the S-1142C/DxxA Series.
 Refer to "1. Product name" regarding the contents of product name, "2. Package" regarding package drawings,
 "3. Product name list" regarding details of the product name.

1. Product name

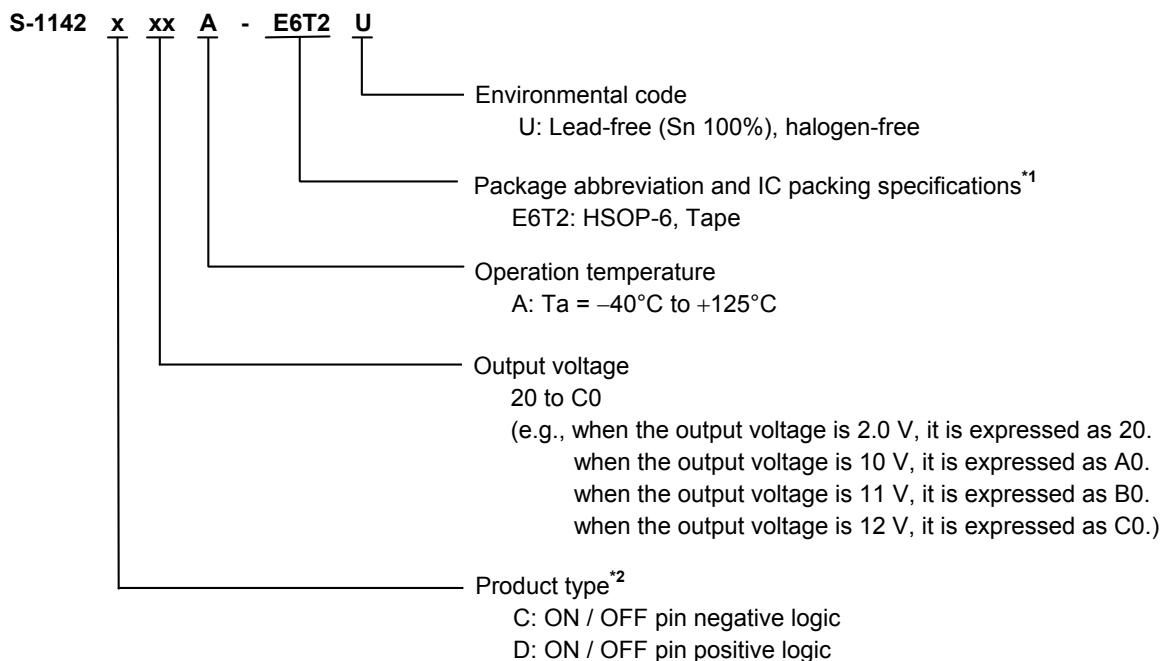

*1. Refer to the tape drawing.

*2. Refer to "3. ON / OFF pin" in "■ Operation".

2. Package

Table 1 Package Drawing Codes

Package Name	Dimension	Tape	Reel	Land
HSOP-6	FH006-A-P-SD	FH006-A-C-SD	FH006-A-R-SD	FH006-A-L-SD

3. Product name list

Table 2

Output Voltage	HSOP-6
3.3 V \pm 1.0%	S-1142D33A-E6T2U
5.0 V \pm 1.0%	S-1142D50A-E6T2U

Remark Please contact our sales office for products with an output voltage other than those listed above or type C products.

■ Pin Configuration

1. HSOP-6

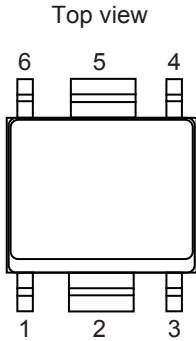

Figure 2

Table 3

Pin No.	Symbol	Description
1	VOUT	Output voltage pin
2	VSS	GND pin
3	ON / OFF	ON / OFF pin
4	NC ^{*1}	No connection
5	VSS	GND pin
6	VIN	Input voltage pin

- The NC pin is electrically open.
 The NC pin can be connected to the VIN pin or the VSS pin.

■ **Absolute Maximum Ratings**

Table 4

(Ta = +25°C unless otherwise specified)

Item	Symbol	Absolute Maximum Rating	Unit
Input voltage	V _{IN}	V _{SS} - 0.3 to V _{SS} + 60	V
	V _{ON/OFF}	V _{SS} - 0.3 to V _{IN} + 0.3	V
Output voltage	V _{OUT}	V _{SS} - 0.3 to V _{IN} + 0.3	V
Power dissipation	P _D	2070 ^{*1}	mW
Junction temperature	T _J	-40 to +135	°C
Operation ambient temperature	T _{opr}	-40 to +125	°C
Storage temperature	T _{stg}	-40 to +135	°C

*1. When mounted on board
 [Mounted board]

- (1) Board size: 50 mm × 50 mm × t1.6 mm
- (2) Board material: Glass epoxy resin (two layers)
- (3) Wiring ratio: 50%
- (4) Test conditions: When mounted on board (wind speed: 0 m/s)
- (5) Land pattern: Refer to the recommended land pattern (drawing code: FH006-A-L-SD)

Caution The absolute maximum ratings are rated values exceeding which the product could suffer physical damage. These values must therefore not be exceeded under any conditions.

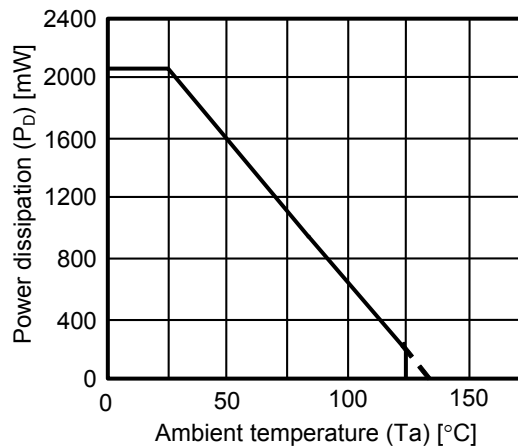

Figure 3 Power Dissipation of Package (When Mounted on Board)

Table 5

Condition	Power Dissipation	Thermal Resistance Value (θj - a)
HSOP-6 (When mounted on board)	2070 mW	53°C/W

■ Electrical Characteristics

Table 6

($V_{IN} = 13.5\text{ V}$, $T_j = -40^\circ\text{C}$ to $+135^\circ\text{C}$, $T_a = -40^\circ\text{C}$ to $+125^\circ\text{C}$ unless otherwise specified)

Item	Symbol	Condition	Min.	Typ.	Max.	Unit	Test Circuit	
Output voltage ^{*1}	$V_{OUT(E)}$	$I_{OUT} = 30\text{ mA}$, $-40^\circ\text{C} \leq T_j \leq +125^\circ\text{C}$	$V_{OUT(S)} \times 0.96$	$V_{OUT(S)}$	$V_{OUT(S)} \times 1.04$	V	1	
Output current ^{*2}	I_{OUT}	$V_{IN} \geq V_{OUT(S)} + 2.0\text{ V}$	200^{*4}	–	–	mA	3	
Dropout voltage ^{*3}	V_{drop}	$I_{OUT} = 100\text{ mA}$ $T_a = +25^\circ\text{C}$	$2.0\text{ V} \leq V_{OUT(S)} < 2.2\text{ V}$	–	1.0	–	V	1
			$2.2\text{ V} \leq V_{OUT(S)} < 2.4\text{ V}$	–	0.8	–	V	1
			$2.4\text{ V} \leq V_{OUT(S)} < 2.6\text{ V}$	–	0.6	–	V	1
			$2.6\text{ V} \leq V_{OUT(S)} < 3.0\text{ V}$	–	0.45	–	V	1
			$3.0\text{ V} \leq V_{OUT(S)} < 3.5\text{ V}$	–	0.35	–	V	1
			$3.5\text{ V} \leq V_{OUT(S)} < 4.0\text{ V}$	–	0.3	–	V	1
			$4.0\text{ V} \leq V_{OUT(S)} < 5.0\text{ V}$	–	0.27	–	V	1
			$5.0\text{ V} \leq V_{OUT(S)} < 7.0\text{ V}$	–	0.23	–	V	1
			$7.0\text{ V} \leq V_{OUT(S)} < 9.0\text{ V}$	–	0.2	–	V	1
		$9.0\text{ V} \leq V_{OUT(S)} \leq 12.0\text{ V}$	–	0.18	–	V	1	
		$I_{OUT} = 200\text{ mA}$ $T_a = +25^\circ\text{C}$	$2.0\text{ V} \leq V_{OUT(S)} < 2.2\text{ V}$	–	1.12	–	V	1
			$2.2\text{ V} \leq V_{OUT(S)} < 2.4\text{ V}$	–	1.02	–	V	1
			$2.4\text{ V} \leq V_{OUT(S)} < 2.6\text{ V}$	–	0.92	–	V	1
			$2.6\text{ V} \leq V_{OUT(S)} < 3.0\text{ V}$	–	0.82	–	V	1
			$3.0\text{ V} \leq V_{OUT(S)} < 3.5\text{ V}$	–	0.72	–	V	1
			$3.5\text{ V} \leq V_{OUT(S)} < 4.0\text{ V}$	–	0.62	–	V	1
			$4.0\text{ V} \leq V_{OUT(S)} < 5.0\text{ V}$	–	0.55	–	V	1
			$5.0\text{ V} \leq V_{OUT(S)} < 7.0\text{ V}$	–	0.5	–	V	1
$7.0\text{ V} \leq V_{OUT(S)} < 9.0\text{ V}$	–		0.45	–	V	1		
$9.0\text{ V} \leq V_{OUT(S)} \leq 12.0\text{ V}$	–	0.4	–	V	1			
Line regulation	$\frac{\Delta V_{OUT1}}{\Delta V_{IN} \cdot V_{OUT}}$	$V_{OUT(S)} + 1.0\text{ V} \leq V_{IN} \leq 30\text{ V}$, $I_{OUT} = 30\text{ mA}$	–	0.05	0.3	%/V	1	
Load regulation	ΔV_{OUT2}	$V_{IN} = 13.5\text{ V}$, $2.0\text{ V} \leq V_{OUT(S)} < 5.1\text{ V}$ $0.1\text{ mA} \leq I_{OUT} \leq 40\text{ mA}$	–	20	90	mV	1	
		$V_{IN} = 13.5\text{ V}$, $5.1\text{ V} \leq V_{OUT(S)} \leq 12.0\text{ V}$ $0.1\text{ mA} \leq I_{OUT} \leq 40\text{ mA}$	–	20	220	mV	1	
Current consumption during operation	I_{SS1}	ON / OFF pin = ON, no load	–	4.0	15.0	μA	2	
Current consumption during power-off	I_{SS2}	ON / OFF pin = OFF, no load	–	0.1	3.5	μA	2	
Input voltage	V_{IN}	–	3.0	–	50	V	–	
ON / OFF pin input voltage "H"	V_{SH}	$V_{IN} = 13.5\text{ V}$, $R_L = 1.0\text{ k}\Omega$, determined by V_{OUT} output level	1.5	–	–	V	4	
ON / OFF pin input voltage "L"	V_{SL}	$V_{IN} = 13.5\text{ V}$, $R_L = 1.0\text{ k}\Omega$, determined by V_{OUT} output level	–	–	0.25	V	4	
ON / OFF pin input current "H"	I_{SH}	$V_{IN} = 13.5\text{ V}$, $V_{ON/OFF} = 13.5\text{ V}$	–0.1	–	0.1	μA	4	
ON / OFF pin input current "L"	I_{SL}	$V_{IN} = 13.5\text{ V}$, $V_{ON/OFF} = 0\text{ V}$	–0.1	–	0.1	μA	4	
Ripple rejection	RR	$V_{IN} = 13.5\text{ V}$, $f = 100\text{ Hz}$, $\Delta V_{rip} = 0.5\text{ Vrms}$, $I_{OUT} = 30\text{ mA}$, $T_a = +25^\circ\text{C}$	$2.0\text{ V} \leq V_{OUT(S)} < 2.3\text{ V}$	–	50	–	dB	5
			$2.3\text{ V} \leq V_{OUT(S)} < 3.6\text{ V}$	–	45	–	dB	5
			$3.6\text{ V} \leq V_{OUT(S)} < 6.1\text{ V}$	–	40	–	dB	5
			$6.1\text{ V} \leq V_{OUT(S)} < 10.1\text{ V}$	–	35	–	dB	5
			$10.1\text{ V} \leq V_{OUT(S)} \leq 12.0\text{ V}$	–	30	–	dB	5
Short-circuit current	I_{short}	$V_{IN} = 13.5\text{ V}$, ON / OFF pin = ON, $V_{OUT} = 0\text{ V}$, $T_a = +25^\circ\text{C}$	–	80	–	mA	3	
Thermal shutdown detection temperature	T_{SD}	Junction temperature	–	155	–	$^\circ\text{C}$	–	
Thermal shutdown release temperature	T_{SR}	Junction temperature	–	130	–	$^\circ\text{C}$	–	

-
- *1. $V_{OUT(S)}$: Set output voltage
 $V_{OUT(E)}$: Actual output voltage
The output voltage when fixing I_{OUT} (= 30 mA) and inputting 13.5 V
 - *2. The output current at which the output voltage becomes 95% of $V_{OUT(E)}$ after gradually increasing the output current.
 - *3. $V_{drop} = V_{IN1} - (V_{OUT3} \times 0.98)$
 V_{OUT3} is the output voltage when $V_{IN} = V_{OUT(S)} + 2.0$ V, and $I_{OUT} = 100$ mA or 200 mA.
 V_{IN1} is the input voltage at which the output voltage becomes 98% of V_{OUT3} after gradually decreasing the input voltage.
 - *4. The output current can be at least this value.
Due to limitation of the package power dissipation, this value may not be satisfied. Attention should be paid to the power dissipation of the package when the output current is large.
This specification is guaranteed by design.

■ **Test Circuits**

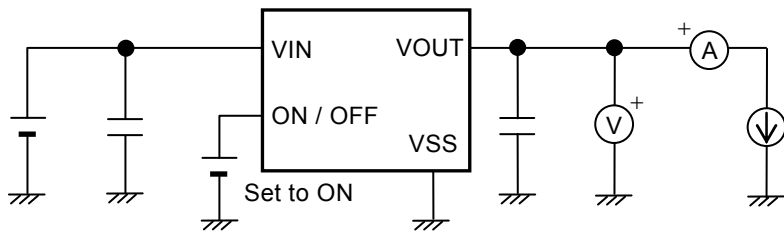

Figure 4 Test Circuit 1

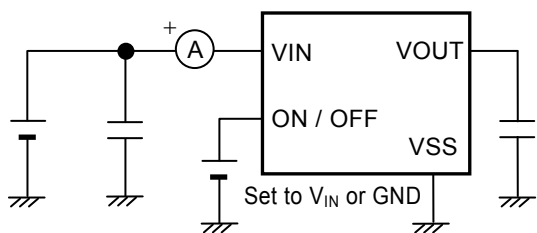

Figure 5 Test Circuit 2

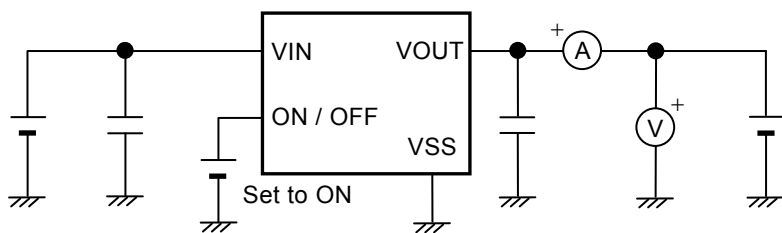

Figure 6 Test Circuit 3

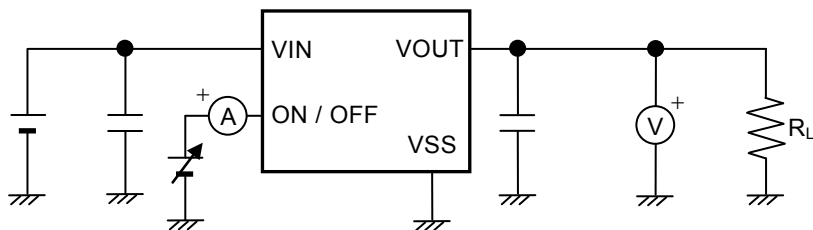

Figure 7 Test Circuit 4

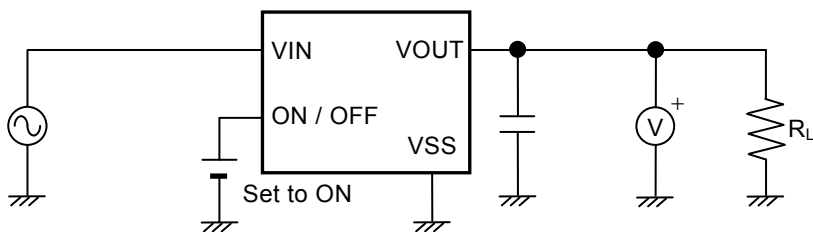
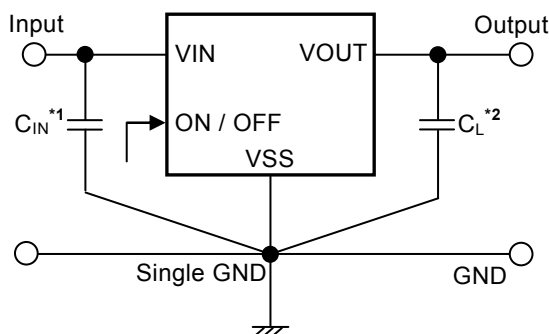

Figure 8 Test Circuit 5

■ Standard Circuit



*1. C_{IN} is a capacitor for stabilizing the input.

*2. A ceramic capacitor of 0.1 μF or more can be used as C_L .

Figure 9

Caution The above connection diagram and constants will not guarantee successful operation. Perform thorough evaluation using an actual application to set the constants.

■ Condition of Application

Input capacitor (C_{IN}): 0.1 μF or more

Output capacitor (C_L): 0.1 μF or more

Caution Generally a series regulator may cause oscillation, depending on the selection of external parts. Confirm that no oscillation occurs in the application for which the above capacitors are used.

■ Selection of Input and Output Capacitors (C_{IN} , C_L)

The S-1142C/DxxA Series requires an output capacitor between the VOUT pin and the VSS pin for phase compensation. Operation is stabilized by a ceramic capacitor with an output capacitance of 0.1 μF or more over the entire temperature range. When using an OS capacitor, a tantalum capacitor, or an aluminum electrolytic capacitor, the capacitance must be 0.1 μF or more.

The values of output overshoot and undershoot, which are transient response characteristics, vary depending on the value of the output capacitor.

The required value of capacitance for the input capacitor differs depending on the application.

Set the value for input capacitor (C_{IN}) and output capacitor (C_L) as follows.

$$C_{IN} \geq 0.1 \mu\text{F}$$

$$C_L \geq 0.1 \mu\text{F}$$

Caution Define the capacity values of C_{IN} and C_L by sufficient evaluation including the temperature characteristics under the actual usage conditions.

■ Explanation of Terms

1. Low dropout voltage regulator

This voltage regulator has the low dropout voltage due to its built-in low on-resistance transistor.

2. Output voltage (V_{OUT})

The accuracy of the output voltage is ensured at $\pm 4.0\%$ under specified conditions of fixed input voltage^{*1}, fixed output current, and fixed temperature.

*1. Differs depending on the product.

Caution If the above conditions change, the output voltage value may vary and exceed the accuracy range of the output voltage. Refer to "■ Electrical Characteristics" and "■ Characteristics (Typical Data)" for details.

3. Line regulation $\left(\frac{\Delta V_{OUT1}}{\Delta V_{IN} \bullet V_{OUT}} \right)$

Indicates the dependency of the output voltage against the input voltage. That is, the value shows how much the output voltage changes due to a change in the input voltage after fixing output current constant.

4. Load regulation (ΔV_{OUT2})

Indicates the dependency of the output voltage against the output current. That is, the value shows how much the output voltage changes due to a change in the output current after fixing input voltage constant.

5. Dropout voltage (V_{drop})

Indicates the difference between input voltage (V_{IN1}) and the output voltage when; decreasing input voltage (V_{IN}) gradually until the output voltage has dropped out to the value of 98% of output voltage (V_{OUT3}), which is at $V_{IN} = V_{OUT(S)} + 2.0 \text{ V}$.

$$V_{drop} = V_{IN1} - (V_{OUT3} \times 0.98)$$

■ **Operation**

1. Basic operation

Figure 10 shows the block diagram of the S-1142C/DxxA Series.

The error amplifier compares the reference voltage (V_{ref}) with feedback voltage (V_{fb}), which is the output voltage resistance-divided by feedback resistors (R_s and R_f). It supplies the gate voltage necessary to maintain the constant output voltage which is not influenced by the input voltage and temperature change, to the output transistor.

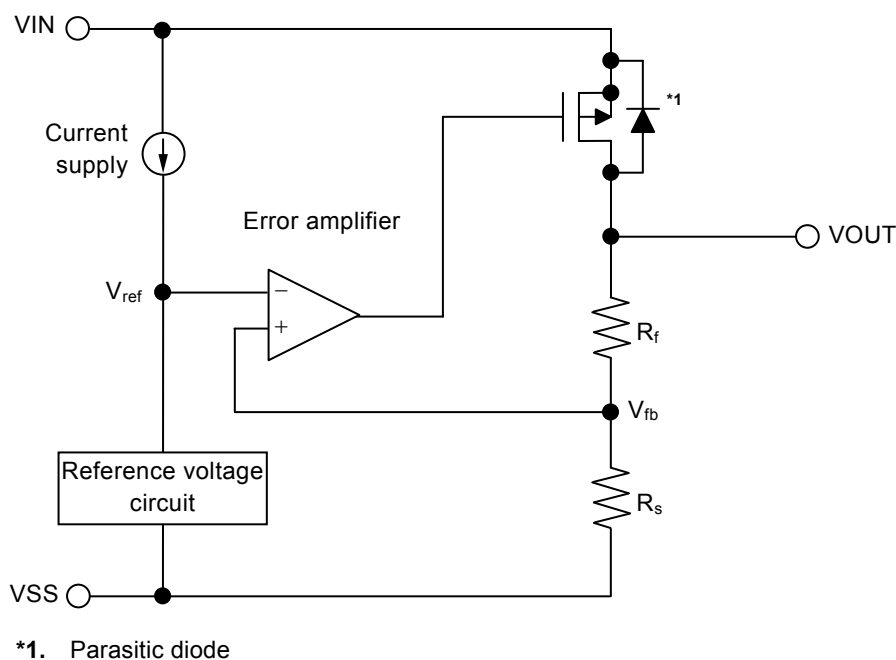

Figure 10

2. Output transistor

In the S-1142C/DxxA Series, a low on-resistance P-channel MOS FET is used as the output transistor.

Be sure that V_{OUT} does not exceed $V_{IN} + 0.3$ V to prevent the voltage regulator from being damaged due to reverse current flowing from the VOUT pin through a parasitic diode to the VIN pin, when the potential of V_{OUT} became higher than V_{IN} .

3. ON / OFF pin

This pin starts and stops the regulator.

When the ON / OFF pin is set to OFF level, the entire internal circuit stops operating, and the built-in P-channel MOS FET output transistor between the VIN pin and the VOUT pin is turned off, reducing current consumption significantly. The VOUT pin is set to the V_{SS} level by the internal dividing resistor of several MΩ between the VOUT pin and the VSS pin.

Note that the current consumption increases when a voltage of 0.3 V to V_{IN} - 0.3 V is applied to the ON / OFF pin. The ON / OFF pin is configured as shown in **Figure 11**. Since the ON / OFF pin is neither pulled down nor pulled up internally, do not use it in the floating status. When not using the ON / OFF pin, connect it to the VSS pin in the product C type, and connect it to the VIN pin in the D type.

Table 7

Product Type	ON / OFF Pin	Internal Circuit	VOUT Pin Voltage	Current Consumption
C	"L": ON	Operate	Set value	I _{SS1}
C	"H": OFF	Stop	V _{SS} level	I _{SS2}
D	"L": OFF	Stop	V _{SS} level	I _{SS2}
D	"H": ON	Operate	Set value	I _{SS1}

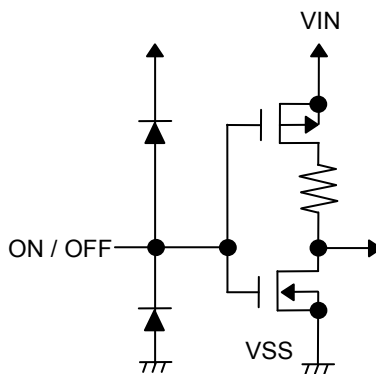

Figure 11

4. Overcurrent protection circuit

The S-1142C/DxxA Series includes an overcurrent protection circuit having the characteristics shown in "1. Output voltage vs. Output current (When load current increases) (Ta = +25°C)" in "■ Characteristics (Typical Data)", in order to protect the output transistor against an excessive output current and short circuiting between the VOUT pin and the VSS pin. The current when the output pin is short-circuited (I_{short}) is internally set at approx. 80 mA typ., and the normal value is restored for the output voltage, if releasing a short circuit once.

Caution This overcurrent protection circuit does not work as for thermal protection. If this IC long keeps short circuiting inside, pay attention to the conditions of input voltage and load current so that, under the usage conditions including short circuit, the loss of the IC will not exceed power dissipation of the package.

5. Thermal shutdown circuit

The S-1142C/DxxA Series has a thermal shutdown circuit to protect the device from damage due to overheat. When the junction temperature rises to 155°C typ., the thermal shutdown circuit operates to stop regulating. When the junction temperature drops to 130°C typ., the thermal shutdown circuit is released to restart regulating. Due to self-heating of the S-1142C/DxxA Series, if the thermal shutdown circuit starts operating, it stops regulating so that the output voltage drops. When regulation stops, the S-1142C/DxxA Series does not itself generate heat and the IC's temperature drops. When the temperature drops, the thermal shutdown circuit is released to restart regulating, thus this IC generates heat again. Repeating this procedure makes the waveform of the output voltage into a pulse-like form. Stop or restart of regulation continues unless decreasing either or both of the input voltage and the output current in order to reduce the internal power consumption, or decreasing the ambient temperature.

Table 8

Thermal Shutdown Circuit	VOUT Pin Voltage
Operate: 155°C typ.*1	V _{SS} level
Release: 130°C typ.*1	Set value

*1. Junction temperature

6. Overshoot of output voltage

Overshoot of output voltage occurs depending on the condition such as the rising speed of input voltage (V_{IN}). Overshoot voltage is the difference between the maximum value of output voltage generated by the fluctuation of V_{IN} and the actual output voltage ($V_{OUT(E)}$) value.

6.1 At normal operation

As shown in **Figure 12**, V_{gs} is the voltage difference between V_{IN} and gate voltage of output driver. The error amplifier controls V_{gs} in order to keep the output voltage constant depending on the fluctuation of V_{IN} and the output load.

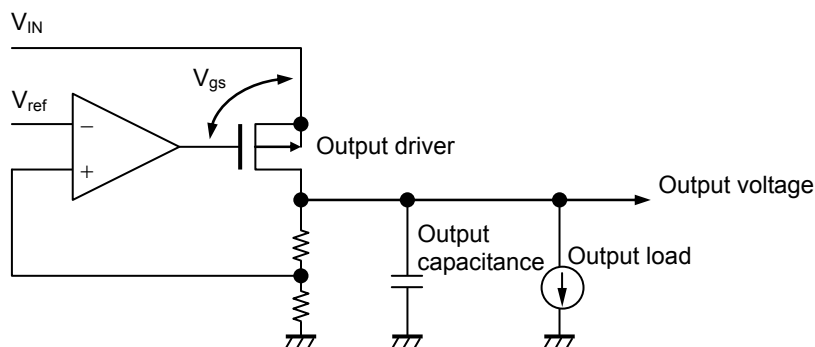

Figure 12 Circuit Diagram

6.2 Occurrence of overshoot

If V_{IN} voltage rises at a fast speed, V_{gs} may become large when gate voltage of output driver can not follow the speed of V_{IN} . When V_{gs} becomes large, the current supplied from output driver is increased transiently. Thereby, output voltage rises, and then overshoot occurs.

Note that overshoot voltage is greatly affected by the following use conditions or temperature, etc.

- When V_{IN} rises in the range of 2.0 V to $V_{OUT(E)}$.
- When the rising speed of V_{IN} is fast.
- When the output capacitance is small.
- When the output load is small.

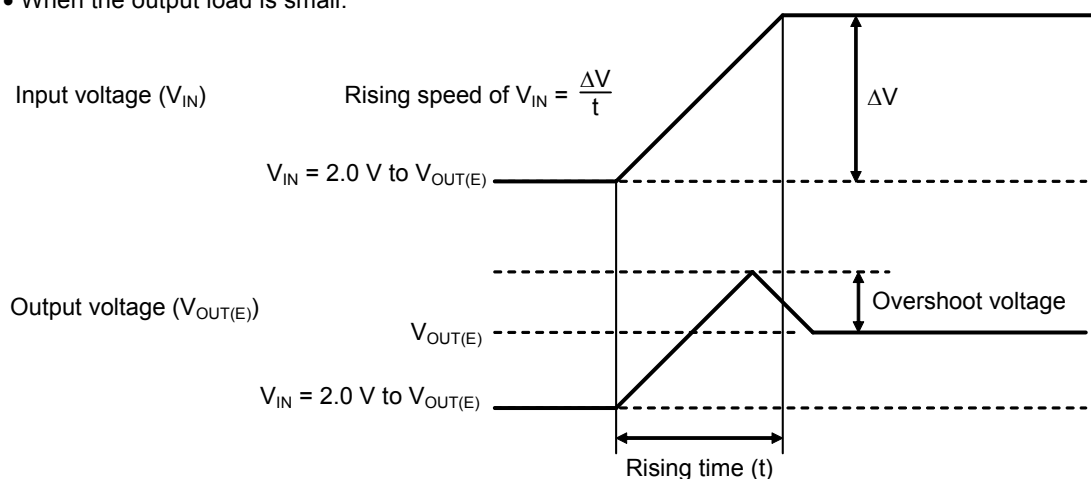

Figure 13 V_{IN} and Overshoot Voltage

Caution Under the following conditions, overshoot voltage tends to become larger especially.

- When V_{IN} rises from around 98% of $V_{OUT(E)}$.
- When the rising speed of V_{IN} is 200 mV/ μ s or more.

■ Precautions

- Wiring patterns for the VIN pin, the VOUT pin and GND should be designed so that the impedance is low. When mounting an output capacitor between the VOUT pin and the VSS pin (C_L) and a capacitor for stabilizing the input between the VIN pin and the VSS pin (C_{IN}), the distance from the capacitors to these pins should be as short as possible.
- Note that generally the output voltage may increase when a series regulator is used at low load current (0.1 mA or less).
- Note that generally the output voltage may increase due to the leakage current from an output driver when a series regulator is used at high temperature.
- Note that the output voltage may increase due to the leakage current from an output driver even if the ON / OFF pin is at OFF level when a series regulator is used at high temperature.
- Generally a series regulator may cause oscillation, depending on the selection of external parts. The following conditions are recommended for the S-1142C/DxxA Series. However, be sure to perform sufficient evaluation under the actual usage conditions for selection, including evaluation of temperature characteristics. Refer to "6. Example of equivalent series resistance vs. Output current characteristics ($T_a = +25^\circ\text{C}$)" in "■ Reference Data" for the equivalent series resistance (R_{ESR}) of the output capacitor.

Input capacitor (C_{IN}):	0.1 μF or more
Output capacitor (C_L):	0.1 μF or more

- The voltage regulator may oscillate when the impedance of the power supply is high and the input capacitance is small or an input capacitor is not connected.
- Sufficiently evaluate the output voltage fluctuations caused by the power supply or the load fluctuations with the actual device.
- Overshoot may occur in the output voltage momentarily if the voltage is rapidly raised at power-on or when the power supply fluctuates. Sufficiently evaluate the output voltage at power-on with the actual device.
- The application conditions for the input voltage, the output voltage, and the load current should not exceed the package power dissipation.
- Do not apply an electrostatic discharge to this IC that exceeds the performance ratings of the built-in electrostatic protection circuit.
- In determining the output current, attention should be paid to the output current value specified in **Table 6** in "■ Electrical Characteristics" and footnote *4 of the table.
- ABLIC Inc. claims no responsibility for any disputes arising out of or in connection with any infringement by products including this IC of patents owned by a third party.

■ Characteristics (Typical Data)

1. Output voltage vs. Output current (When load current increases) ($T_a = +25^\circ\text{C}$)

1.1 $V_{\text{OUT}} = 2.0\text{ V}$

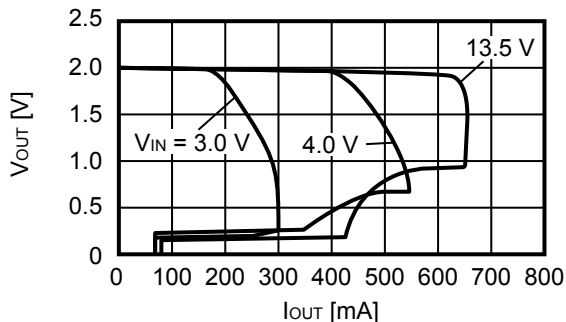

1.2 $V_{\text{OUT}} = 5.0\text{ V}$

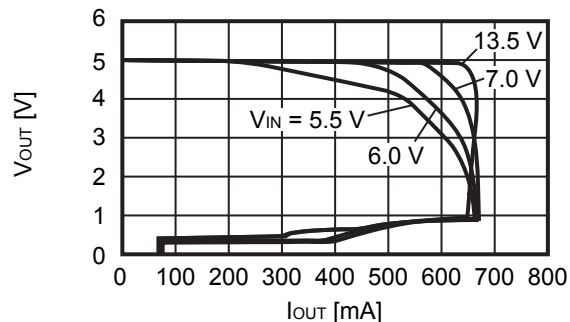

1.3 $V_{\text{OUT}} = 12.0\text{ V}$

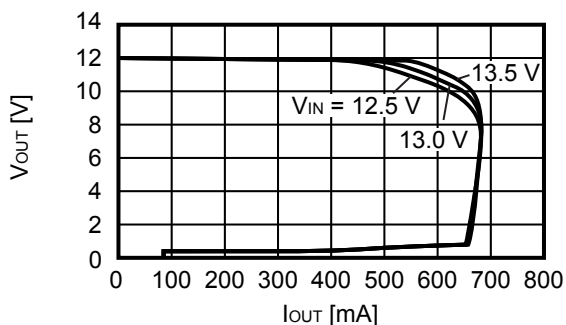

Remark In determining the output current, attention should be paid to the following.

1. The minimum output current value and footnote *4 of Table 6 in "■ Electrical Characteristics"
2. Power dissipation of the package

2. Output voltage vs. Input voltage ($T_a = +25^\circ\text{C}$)

2.1 $V_{\text{OUT}} = 2.0\text{ V}$

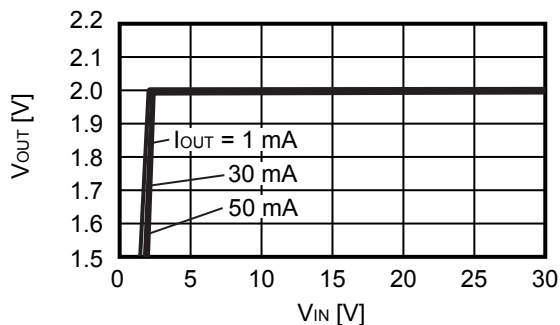

2.2 $V_{\text{OUT}} = 5.0\text{ V}$

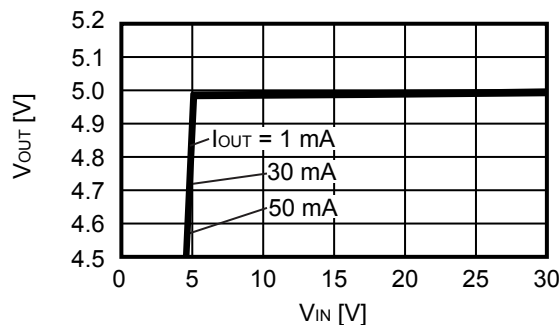

2.3 $V_{\text{OUT}} = 12.0\text{ V}$

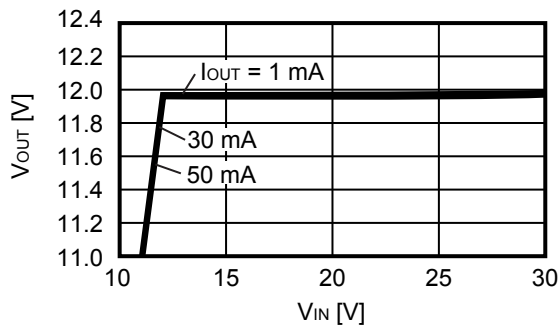

3. Dropout voltage vs. Output current

3.1 $V_{OUT} = 2.0\text{ V}$

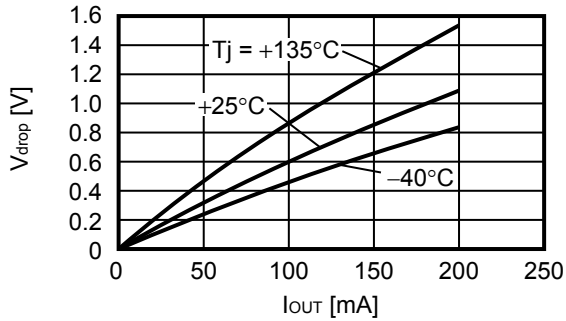

3.2 $V_{OUT} = 5.0\text{ V}$

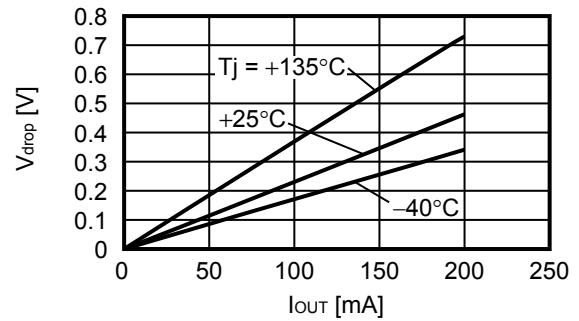

3.3 $V_{OUT} = 12.0\text{ V}$

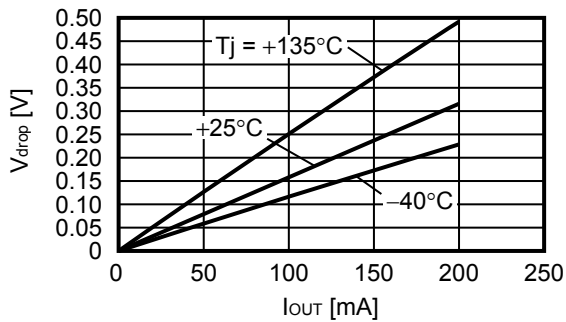

4. Dropout voltage vs. Temperature

4.1 $V_{OUT} = 2.0\text{ V}$

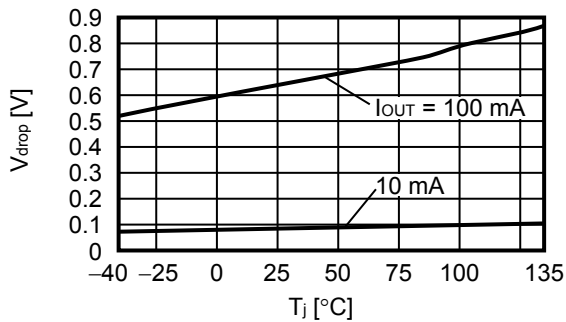

4.2 $V_{OUT} = 5.0\text{ V}$

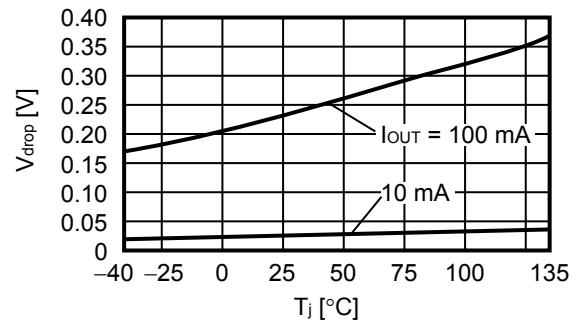

4.3 $V_{OUT} = 12.0\text{ V}$

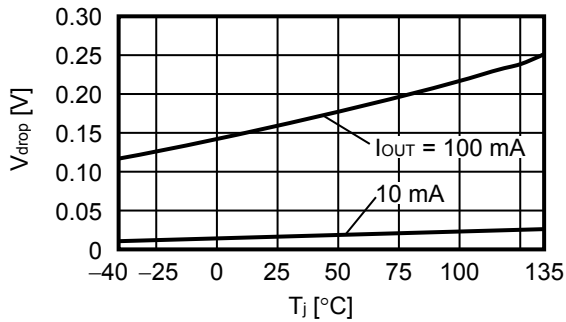

5. Dropout voltage vs. Set output voltage ($T_j = +25^\circ\text{C}$)

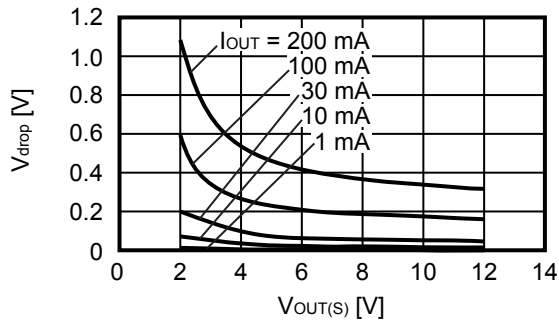

6. Output voltage vs. Temperature

6.1 $V_{OUT} = 2.0$ V

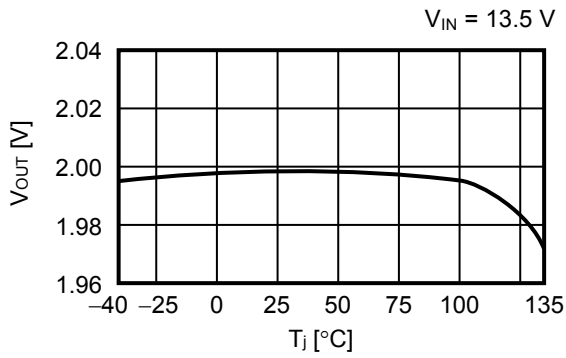

6.2 $V_{OUT} = 5.0$ V

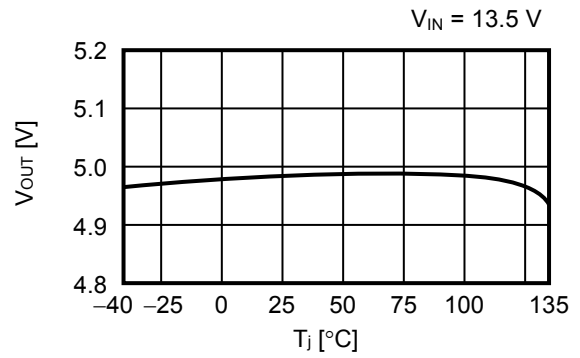

6.3 $V_{OUT} = 12.0$ V

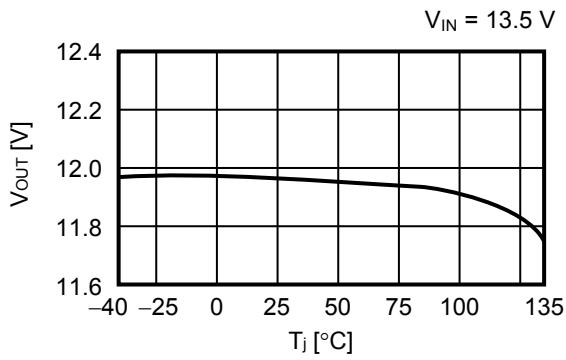

7. Current consumption during operation vs. Input voltage (When ON / OFF pin is ON, no load)

7.1 $V_{OUT} = 2.0\text{ V}$

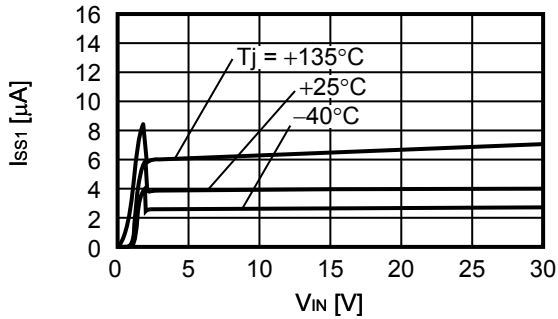

7.2 $V_{OUT} = 5.0\text{ V}$

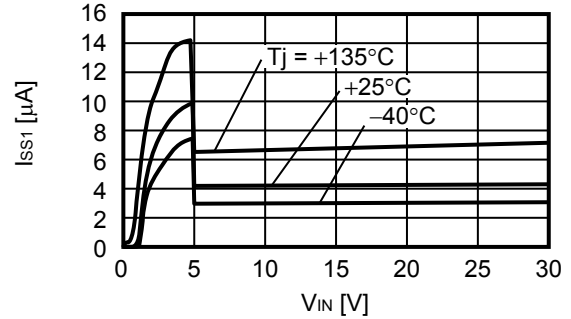

7.3 $V_{OUT} = 12.0\text{ V}$

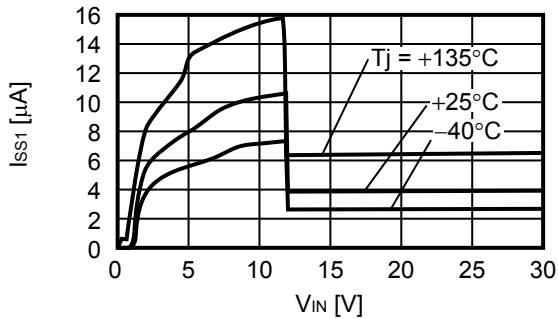

8. Current consumption during operation vs. Temperature

8.1 $V_{OUT} = 2.0\text{ V}$

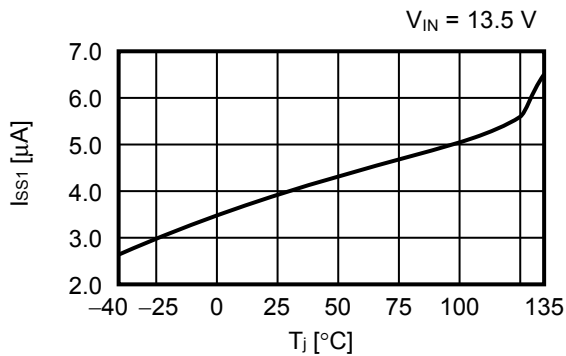

8.2 $V_{OUT} = 5.0\text{ V}$

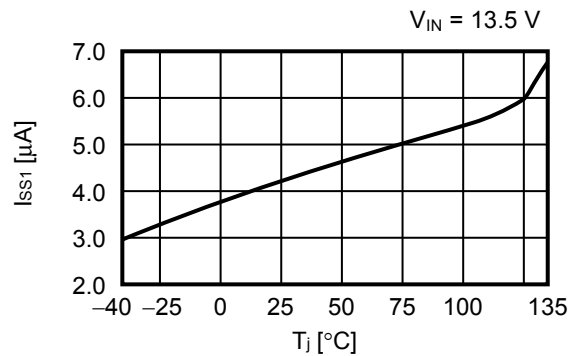

8.3 $V_{OUT} = 12.0\text{ V}$

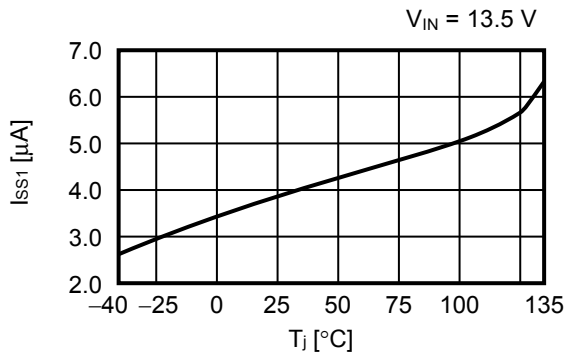

9. Current consumption during operation vs. Output current (Ta = +25°C)

9.1 V_{OUT} = 2.0 V

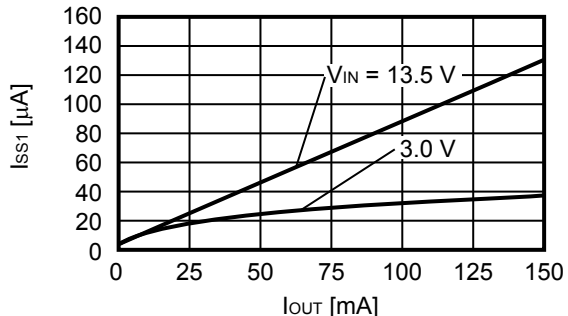

9.2 V_{OUT} = 5.0 V

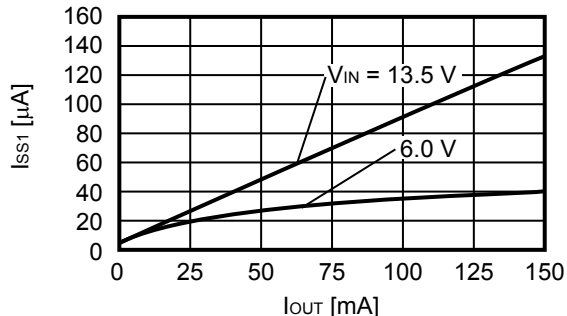

9.3 V_{OUT} = 12.0 V

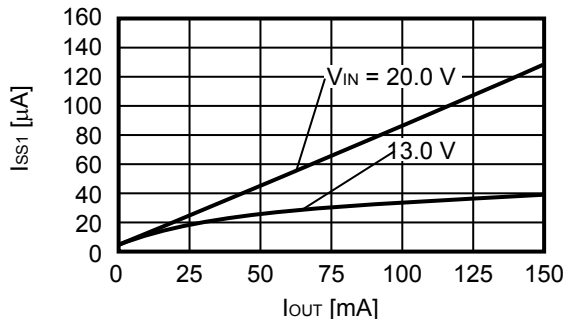

10. Output current vs. Input voltage^{*1}

10.1 V_{OUT} = 3.3 V

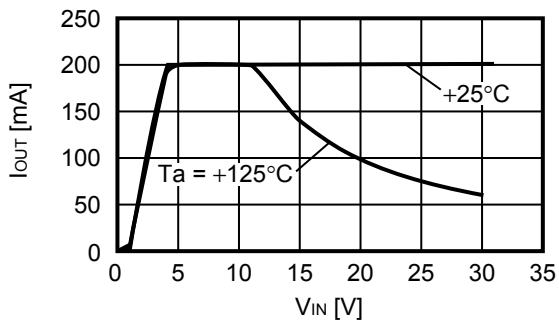

*1. When mounted on board
 [Mounted board]

- (1) Board size: 50 mm × 50 mm × t1.6 mm
- (2) Board material: Glass epoxy resin (two layers)
- (3) Wiring ratio: Surface approx. 75%, reverse side approx. 90%
- (4) Through hole: Diameter 0.5 mm × 24

11. Ripple rejection ($T_a = +25^\circ\text{C}$)

11.1 $V_{OUT} = 2.0\text{ V}$

$V_{IN} = 13.5\text{ V}, C_L = 0.1\ \mu\text{F}$

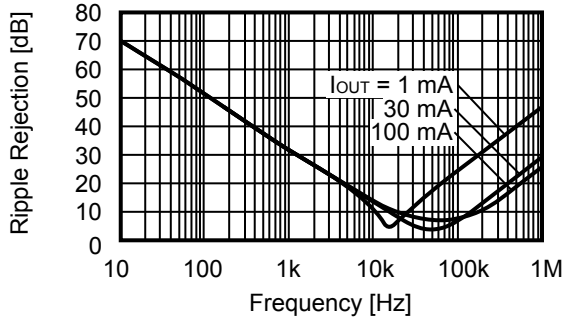

11.2 $V_{OUT} = 5.0\text{ V}$

$V_{IN} = 13.5\text{ V}, C_L = 0.1\ \mu\text{F}$

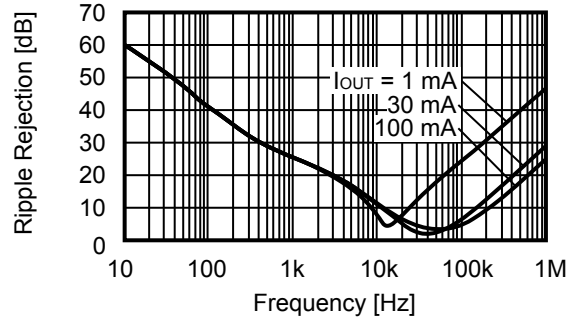

11.3 $V_{OUT} = 12.0\text{ V}$

$V_{IN} = 13.5\text{ V}, C_L = 0.1\ \mu\text{F}$

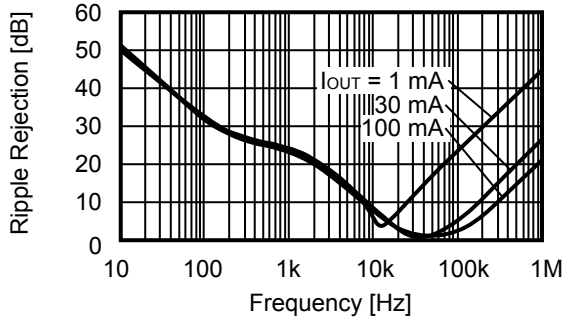

■ Reference Data

1. Characteristics of input transient response (Ta = +25°C)

1.1 V_{OUT} = 2.0 V

I_{OUT} = 30 mA, C_{IN} = 0.1 μF, V_{IN} = 11.5 V ↔ 13.5 V, t_r = t_f = 5.0 μs

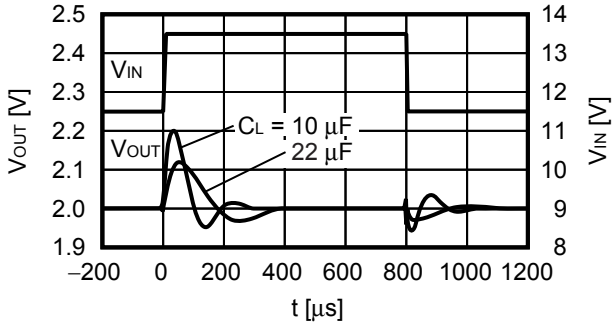

1.2 V_{OUT} = 5.0 V

I_{OUT} = 30 mA, C_{IN} = 0.1 μF, V_{IN} = 11.5 V ↔ 13.5 V, t_r = t_f = 5.0 μs

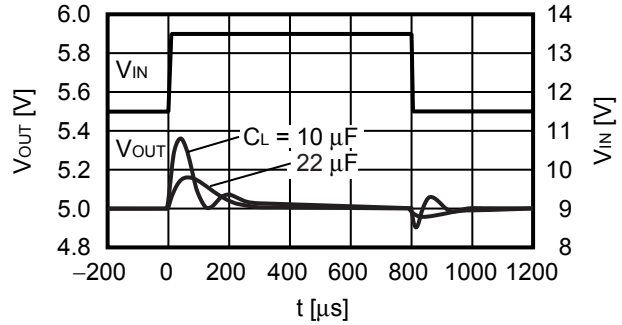

1.3 V_{OUT} = 12.0 V

I_{OUT} = 30 mA, C_{IN} = 0.1 μF, V_{IN} = 13.5 V ↔ 15.5 V, t_r = t_f = 5.0 μs

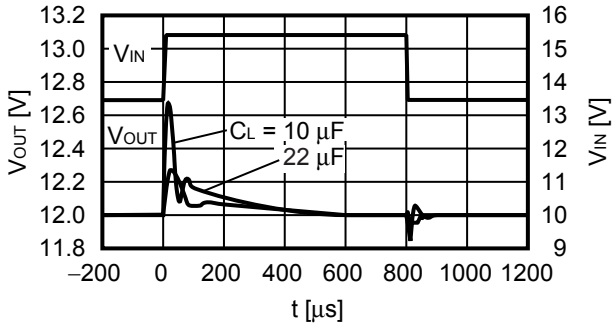

2. Characteristics of load transient response (Ta = +25°C)

2.1 V_{OUT} = 2.0 V

V_{IN} = 13.5 V, C_{IN} = 0.1 μF, I_{OUT} = 50 mA ↔ 100 mA

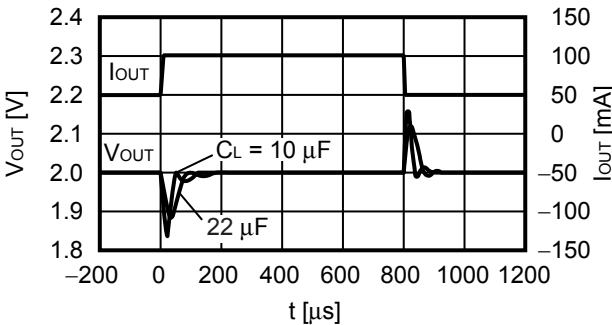

2.2 V_{OUT} = 5.0 V

V_{IN} = 13.5 V, C_{IN} = 0.1 μF, I_{OUT} = 50 mA ↔ 100 mA

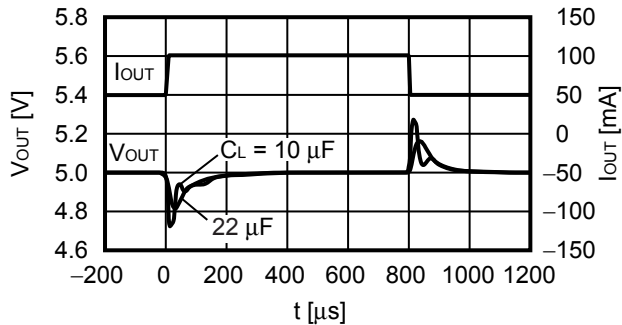

2.3 V_{OUT} = 12.0 V

V_{IN} = 13.5 V, C_{IN} = 0.1 μF, I_{OUT} = 50 mA ↔ 100 mA

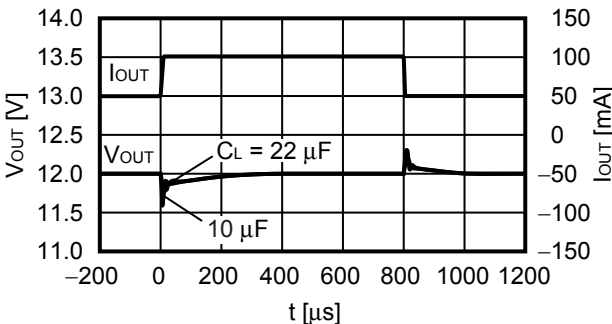

3. Transient response characteristics of ON / OFF pin (Ta = +25°C)

3.1 V_{OUT} = 3.3 V

V_{IN} = 13.5 V, C_L = 10 μF, C_{IN} = 0.1 μF,
 I_{OUT} = 100 mA, V_{ON/OFF} = 0 V → 13.5 V

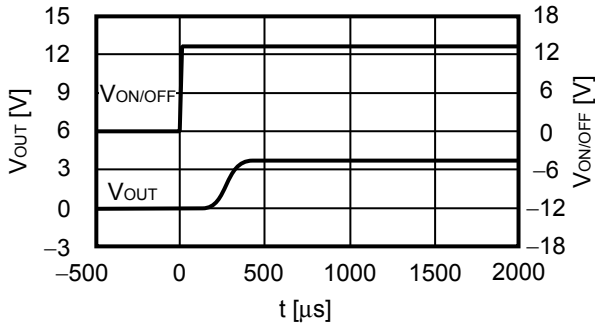

3.2 V_{OUT} = 5.0 V

V_{IN} = 13.5 V, C_L = 10 μF, C_{IN} = 0.1 μF,
 I_{OUT} = 100 mA, V_{ON/OFF} = 0 V → 13.5 V

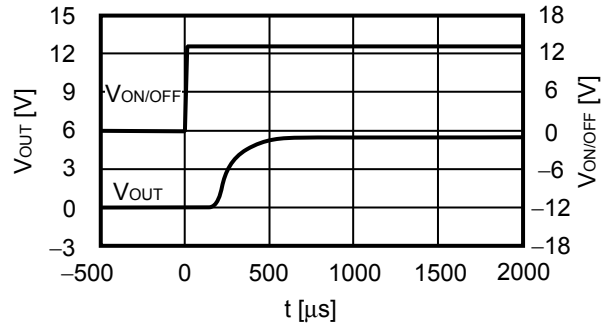

4. Load transient response characteristics dependent on capacitance (Ta = +25°C)

4.1 V_{OUT} = 5.0 V

V_{IN} = 13.5 V, C_{IN} = 0.1 μF, I_{OUT} = 50 mA → 100 mA

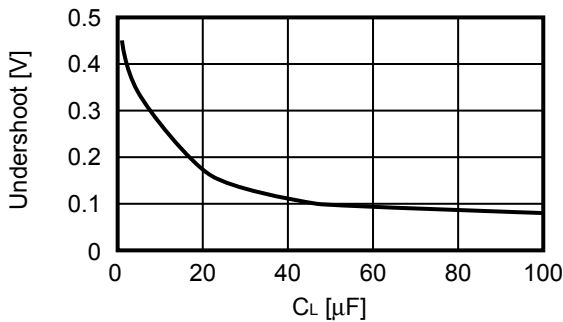

V_{IN} = 13.5 V, C_{IN} = 0.1 μF, I_{OUT} = 100 mA → 50 mA

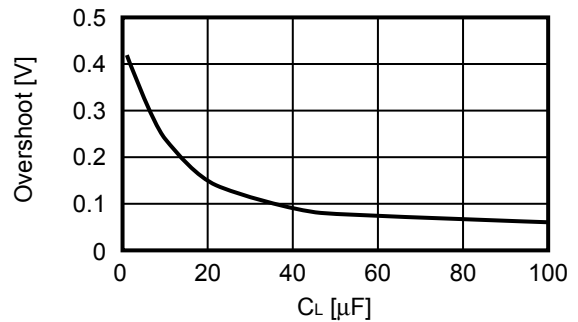

5. Input transient response characteristics dependent on capacitance (Ta = +25°C)

5.1 V_{OUT} = 5.0 V

V_{IN} = 7.0 V → 12.0 V, t_r = 5.0 μs, C_{IN} = 0.1 μF, I_{OUT} = 30 mA

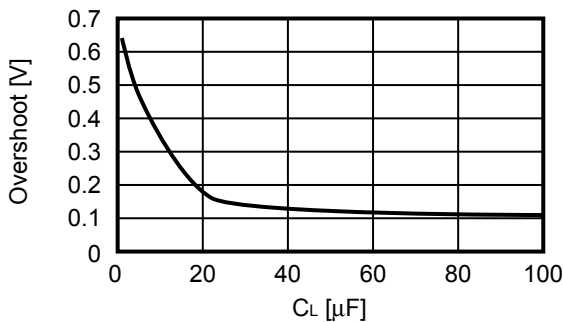

V_{IN} = 12.0 V → 7.0 V, t_r = 5.0 μs, C_{IN} = 0.1 μF, I_{OUT} = 30 mA

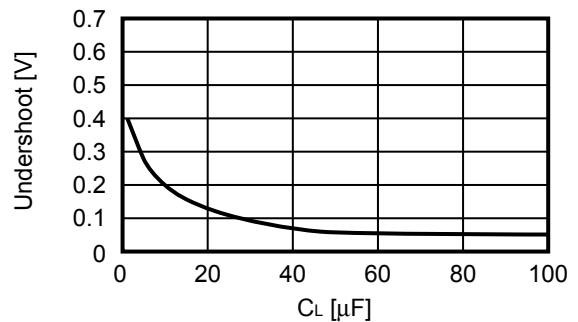

6. Example of equivalent series resistance vs. Output current characteristics (Ta = +25°C)

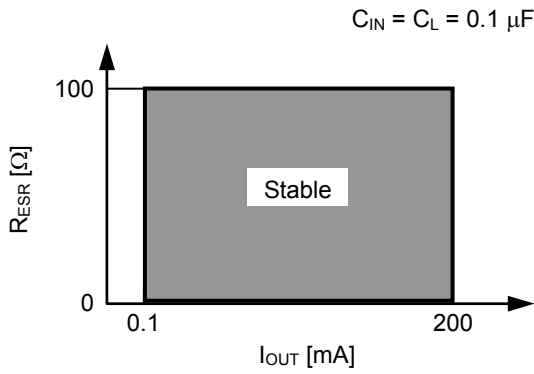

Figure 14

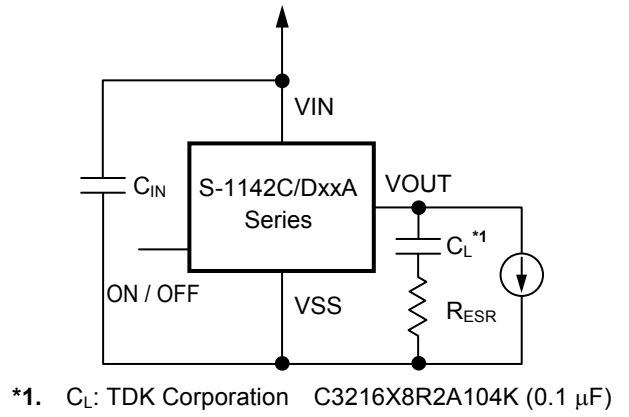
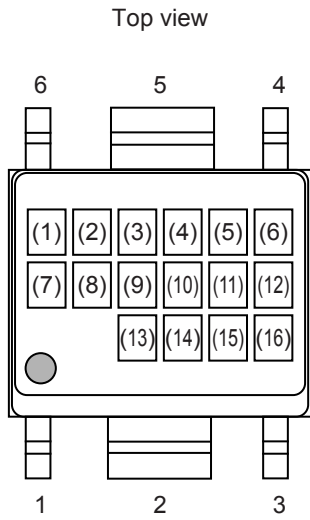

Figure 15

■ Marking Specification

1. HSOP-6



- (1) to (5): Product name: S1142 (Fixed)
- (6): Product type
- (7) and (8): Value of output voltage
- (9): Operation temperature
- (10) to (16): Lot number

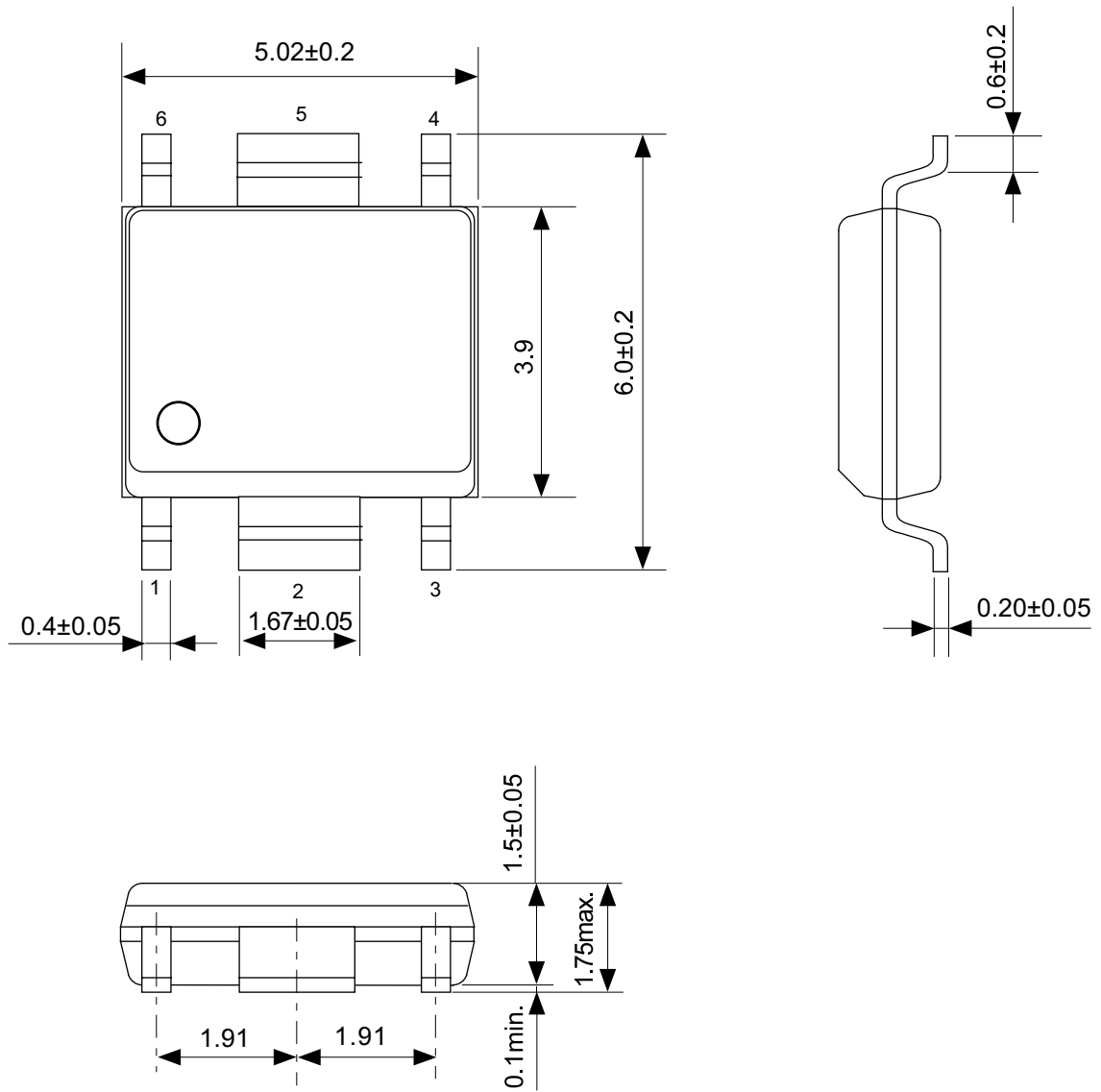

No. FH006-A-P-SD-2.1

TITLE	HSOP6-A-PKG Dimensions
No.	FH006-A-P-SD-2.1
ANGLE	
UNIT	mm
ABLIC Inc.	

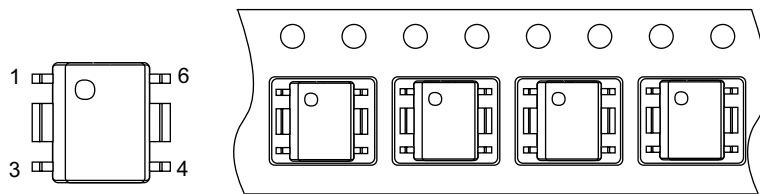
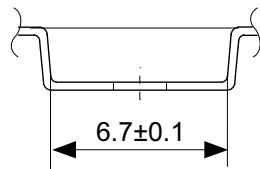
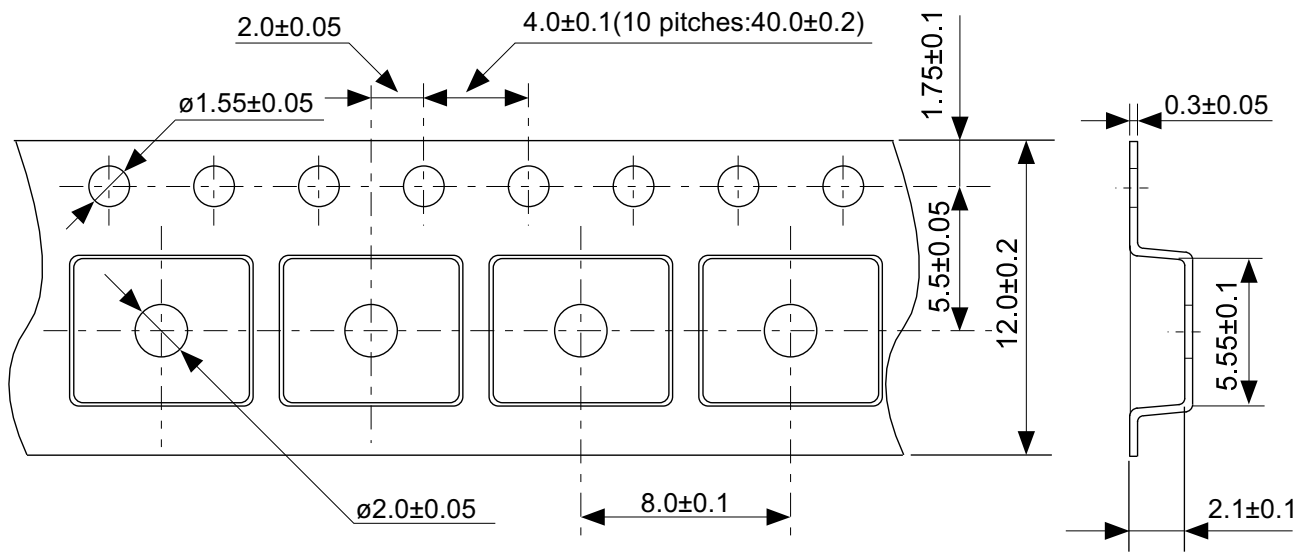

→
Feed direction

No. FH006-A-C-SD-2.0

TITLE	HSOP6-A-Carrier Tape
No.	FH006-A-C-SD-2.0
ANGLE	
UNIT	mm
ABLIC Inc.	

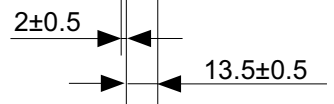
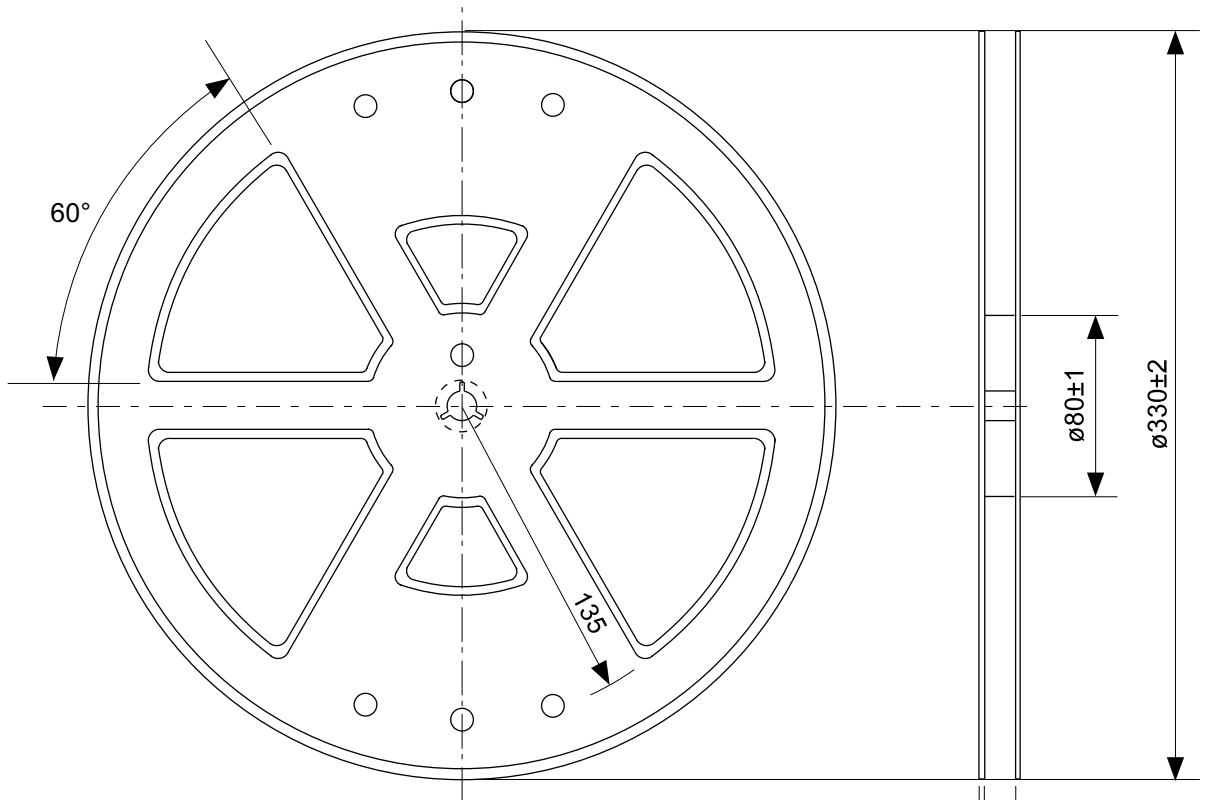

Enlarged drawing in the central part

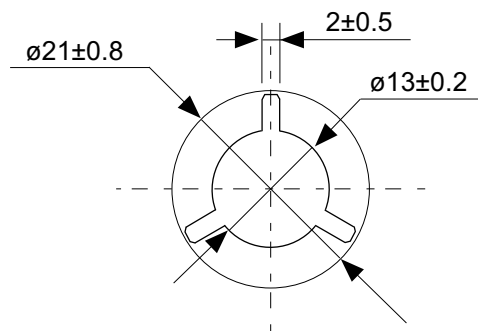

No. FH006-A-R-SD-1.0

TITLE	HSOP6-A-Reel		
No.	FH006-A-R-SD-1.0		
ANGLE		QTY.	2,000
UNIT	mm		
ABLIC Inc.			

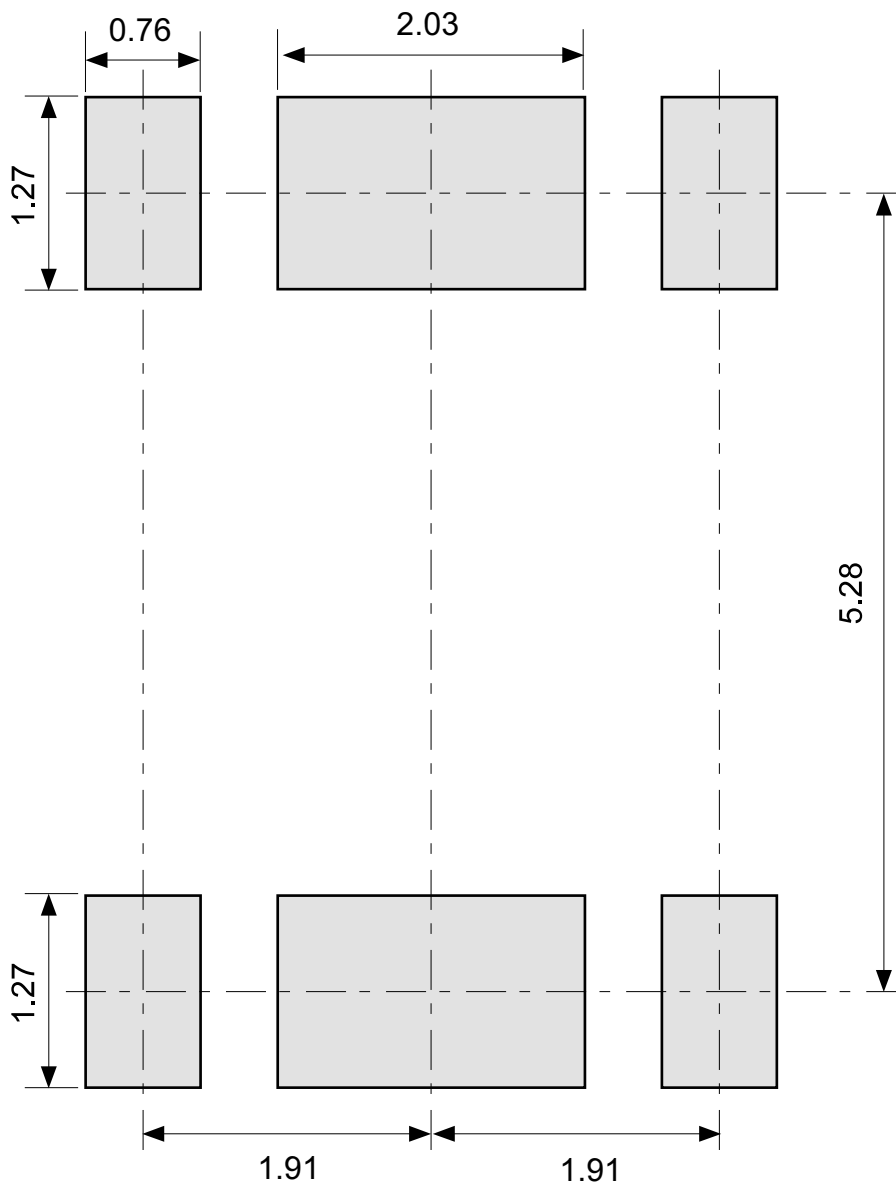

No. FH006-A-L-SD-2.0

TITLE	HSOP6-A -Land Recommendation
No.	FH006-A-L-SD-2.0
ANGLE	
UNIT	mm
ABLIC Inc.	

Disclaimers (Handling Precautions)

1. All the information described herein (product data, specifications, figures, tables, programs, algorithms and application circuit examples, etc.) is current as of publishing date of this document and is subject to change without notice.
2. The circuit examples and the usages described herein are for reference only, and do not guarantee the success of any specific mass-production design.
ABLIC Inc. is not liable for any losses, damages, claims or demands caused by the reasons other than the products described herein (hereinafter "the products") or infringement of third-party intellectual property right and any other right due to the use of the information described herein.
3. ABLIC Inc. is not liable for any losses, damages, claims or demands caused by the incorrect information described herein.
4. Be careful to use the products within their ranges described herein. Pay special attention for use to the absolute maximum ratings, operation voltage range and electrical characteristics, etc.
ABLIC Inc. is not liable for any losses, damages, claims or demands caused by failures and / or accidents, etc. due to the use of the products outside their specified ranges.
5. Before using the products, confirm their applications, and the laws and regulations of the region or country where they are used and verify suitability, safety and other factors for the intended use.
6. When exporting the products, comply with the Foreign Exchange and Foreign Trade Act and all other export-related laws, and follow the required procedures.
7. The products are strictly prohibited from using, providing or exporting for the purposes of the development of weapons of mass destruction or military use. ABLIC Inc. is not liable for any losses, damages, claims or demands caused by any provision or export to the person or entity who intends to develop, manufacture, use or store nuclear, biological or chemical weapons or missiles, or use any other military purposes.
8. The products are not designed to be used as part of any device or equipment that may affect the human body, human life, or assets (such as medical equipment, disaster prevention systems, security systems, combustion control systems, infrastructure control systems, vehicle equipment, traffic systems, in-vehicle equipment, aviation equipment, aerospace equipment, and nuclear-related equipment), excluding when specified for in-vehicle use or other uses by ABLIC, Inc. Do not apply the products to the above listed devices and equipments.
ABLIC Inc. is not liable for any losses, damages, claims or demands caused by unauthorized or unspecified use of the products.
9. In general, semiconductor products may fail or malfunction with some probability. The user of the products should therefore take responsibility to give thorough consideration to safety design including redundancy, fire spread prevention measures, and malfunction prevention to prevent accidents causing injury or death, fires and social damage, etc. that may ensue from the products' failure or malfunction.
The entire system in which the products are used must be sufficiently evaluated and judged whether the products are allowed to apply for the system on customer's own responsibility.
10. The products are not designed to be radiation-proof. The necessary radiation measures should be taken in the product design by the customer depending on the intended use.
11. The products do not affect human health under normal use. However, they contain chemical substances and heavy metals and should therefore not be put in the mouth. The fracture surfaces of wafers and chips may be sharp. Be careful when handling these with the bare hands to prevent injuries, etc.
12. When disposing of the products, comply with the laws and ordinances of the country or region where they are used.
13. The information described herein contains copyright information and know-how of ABLIC Inc. The information described herein does not convey any license under any intellectual property rights or any other rights belonging to ABLIC Inc. or a third party. Reproduction or copying of the information from this document or any part of this document described herein for the purpose of disclosing it to a third-party is strictly prohibited without the express permission of ABLIC Inc.
14. For more details on the information described herein or any other questions, please contact ABLIC Inc.'s sales representative.
15. This Disclaimers have been delivered in a text using the Japanese language, which text, despite any translations into the English language and the Chinese language, shall be controlling.

2.4-2019.07